

OCTA-1-2

A	B	C	GAUGE	SQ. FT.
18	3	6	0.063	2.25
24	3	9	0.063	4.00

A	B	C	THICKNESS	m ²
450	75	150	1.6	0.20
600	75	225	1.6	0.36

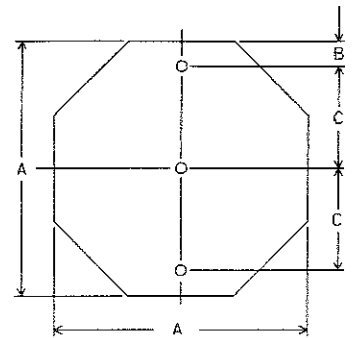

OCTA-1-3

A	B	C	GAUGE	SQ. FT.
30	3	12	0.080	6.25
36	6	12	0.080	9.00

A	B	C	THICKNESS	m ²
750	75	300	2.0	0.56
900	150	300	2.0	0.81

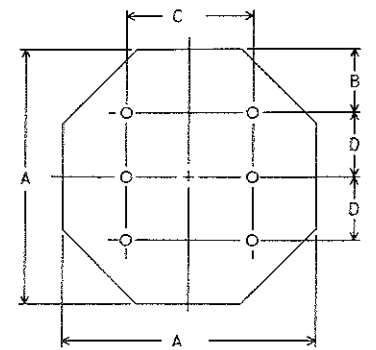

OCTA-2-6

A	B	C	D	GAUGE	SQ. FT.
48	12	24	12	0.100	16.00

A	B	C	D	THICKNESS	m ²
1200	300	600	300	2.5	1.44

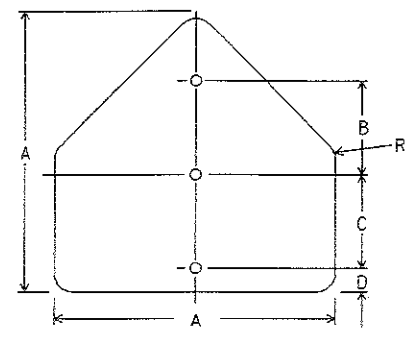

PENT-1-3

A	B	C	D	R	GAUGE	SQ. FT.
30	10	11	3	1.88	0.080	6.25
36	12	12	3	2.25	0.080	9.00
42	14	13	4	2.50	0.100	12.25

A	B	C	D	R	THICKNESS	m ²
750	250	275	75	48	2.0	0.56
900	300	300	75	57	2.0	0.81
1050	350	325	100	64	2.5	1.10

NOTES

1. For each detail shown, the top table is in inches and the lower table is in millimeters unless otherwise noted.
2. All bolt holes shall be 3/8" (10 mm) in diameter, and may be drilled or punched to finished size.
3. Dimensions between bolt holes shall be to tolerance of $\pm 1/32"$ (± 0.8 mm).
4. All route shields shall be 0.063" (1.6 mm) thick and attached to extrusheet signs with aluminum blind rivets.

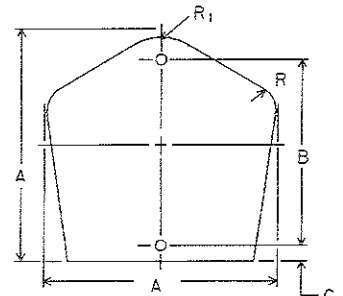
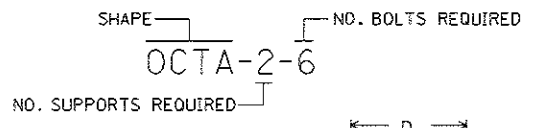

CO-1-2

A	B	C	R ₁	R	GAUGE	SQ. FT.
18	15	1	5	2	0.063	2.25
24	18	2	5.31	2.69	0.063	4.00
30	24	2	6.63	3.38	0.080	6.25

A	B	C	R ₁	R	THICKNESS	m ²
450	375	25	125	50	1.6	0.20
600	450	50	135	68	1.6	0.36
750	600	50	168	86	2.0	0.56

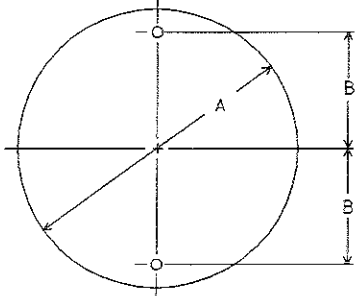

CIR-1-2

A	B	GAUGE	SQ. FT.
18	6	0.063	2.25
24	9	0.063	4.00

A	B	THICKNESS	m ²
450	150	1.6	0.20
600	225	2.0	0.36

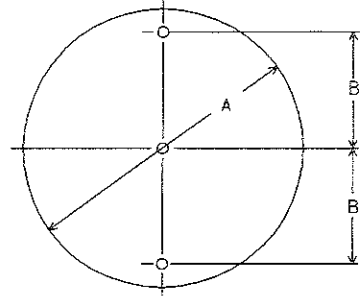

CIR-1-3

A	B	GAUGE	SQ. FT.
30	12	0.080	6.25
36	15	0.080	9.00

A	B	THICKNESS	m ²
750	300	2.0	0.56
900	375	2.0	0.81

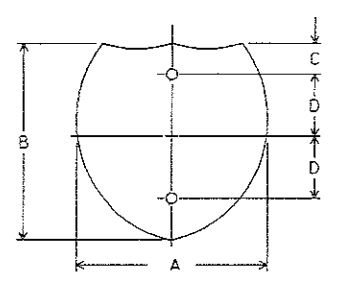

I.S.-1-2

A	B	C	D	GAUGE	SQ. FT.
24	24	3	9	0.063	4.00
30	24	3	9	0.080	5.00
30	30	3	12	0.080	6.25
40	30	3	12	0.080	8.33

A	B	C	D	THICKNESS	m ²
600	600	75	225	1.6	0.36
750	600	75	225	2.0	0.45
750	750	75	300	2.0	0.56
1000	750	75	300	2.0	0.75

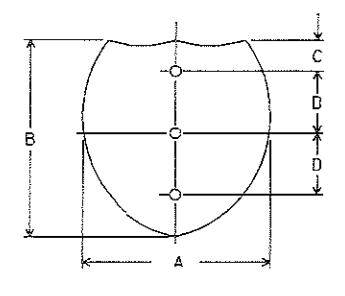

I.S.-1-3

A	B	C	D	GAUGE	SQ. FT.
36	36	6	12	0.080	9.00
48	36	6	12	0.100	12.00

A	B	C	D	THICKNESS	m ²
900	900	150	300	2.0	0.81
1200	900	150	300	2.5	1.08

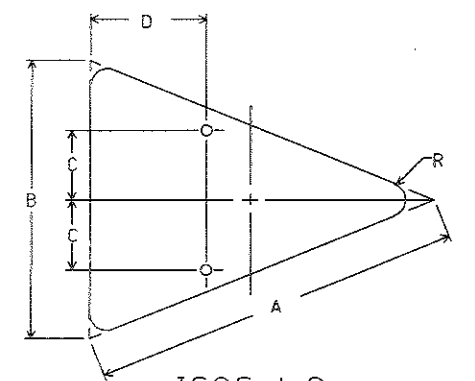

ISOS-1-2

A	B	C	D	R	GAUGE	SQ. FT.
40	30	17.50	12	1.88	0.080	3.86
48	36	9	15	2.25	0.100	5.56

A	B	C	D	R	THICKNESS	m ²
1000	750	187	300	48	2.0	0.35
1200	900	225	375	57	2.5	0.50

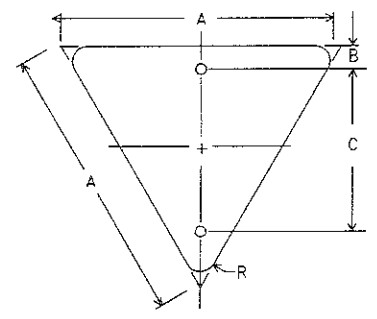

TRI-1-2

A	B	C	R	GAUGE	SQ. FT.
24	2	14	1.50	0.080	1.73

A	B	C	R	THICKNESS	m ²
600	50	350	38	2.0	0.16

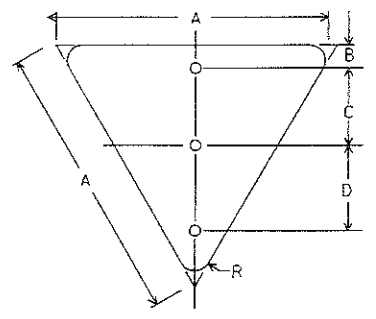

TRI-1-3

A	B	C	D	R	GAUGE	SQ. FT.
36	3	10	11	2.00	0.100	3.90

A	B	C	D	R	THICKNESS	m ²
900	75	250	275	50	2.5	0.35

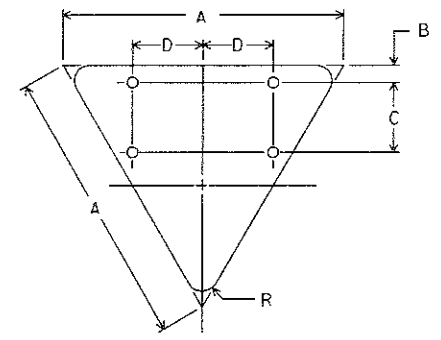

TRI-2-4

A	B	C	D	R	GAUGE	SQ. FT.
48	3	12	12	3	0.100	6.93
60	3	18	15	4	0.100	10.83

A	B	C	D	R	THICKNESS	m ²
1200	75	300	300	75	2.5	0.62
1500	75	450	375	100	2.5	0.97

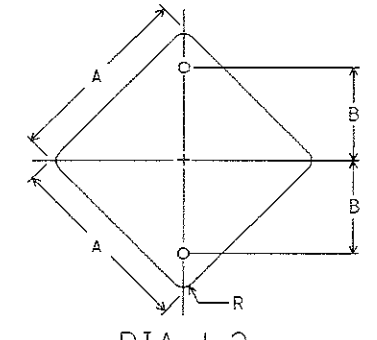

DIA-1-2

A	B	R	GAUGE	SQ. FT.
18	9	11.50	0.063	2.25

A	B	R	THICKNESS	m ²
450	225	38	1.6	0.20

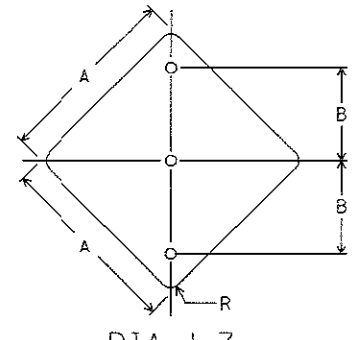

DIA-1-3

A	B	R	GAUGE	SQ. FT.
24	12	15.00	0.063	4.00
30	15	18.88	0.080	6.25
36	18	22.50	0.080	9.00

A	B	R	THICKNESS	m ²
600	300	38	1.6	0.36
750	375	48	2.0	0.56
900	450	57	2.0	0.81

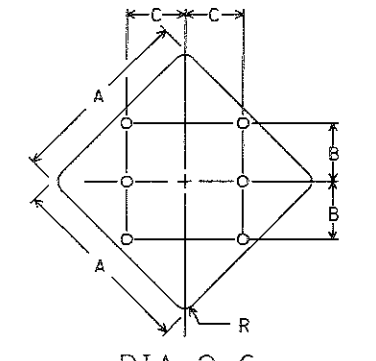

DIA-2-6

A	B	C	R	GAUGE	SQ. FT.
48	15	15	3	0.100	16.00
60	18	18	3.75	0.100	25.00

A	B	C	R	THICKNESS	m ²
1200	375	375	75	2.5	1.44
1500	450	450	95	2.5	2.25