

STRAW OR HAY BALES

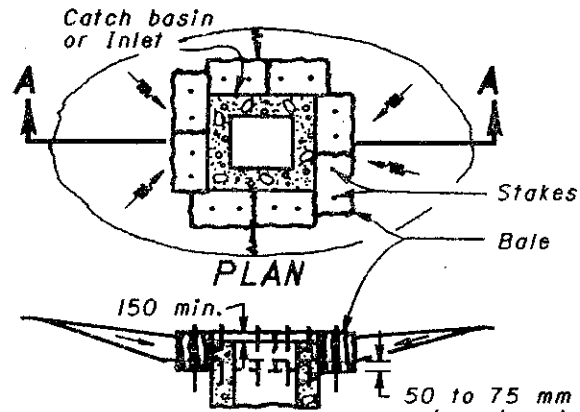

SECTION A-A
BALE INLET FILTER

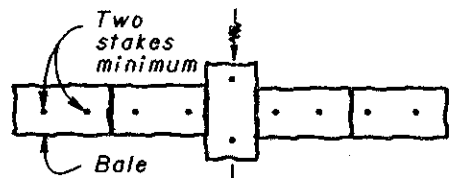

PLAN

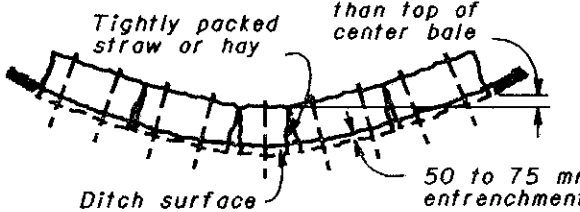

ELEVATION
BALE DITCH CHECK

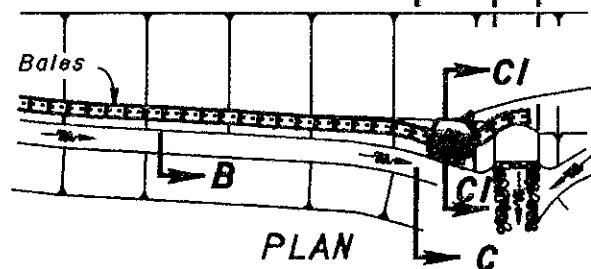
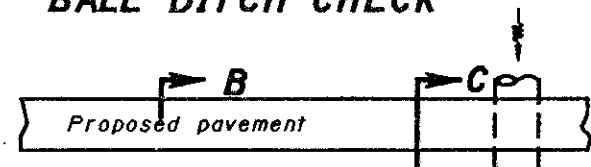

PLAN

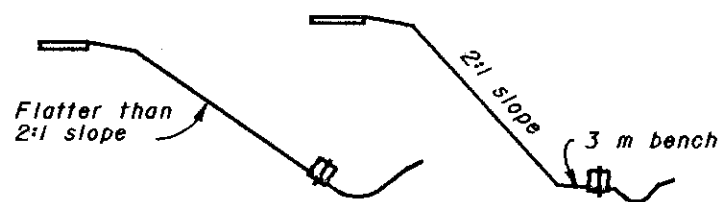

SECTION B-B

SECTION C-C

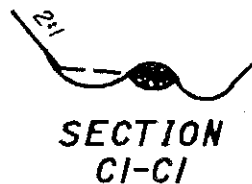

SECTION CI-CI

BALE FILTER DIKE

BALE PLACEMENT: Bales shall be tightly placed adjacently and entrenched 50 mm to 75 mm before staking; or a small amount of loose soil shall be lightly compacted along the upstream edge of the bales.

Each bale shall be firmly staked with a minimum of two stakes at least 1 m in length.

Stakes shall be wooden 50 x 50 mm, reinforcing bars or fence posts, as approved by the Engineer.

Loose straw or hay shall be scattered for a distance of 3 m on the upstream side of each ditch check, and shall be wedged between and under staked bales.

PITS: Sediment pits shall be provided where directed by the Engineer, and their cost included in the unit price bid for the adjacent CMS 207 items.

MAINTENANCE: Sediment shall be removed when its depth reaches half the height of the exposed portion of the lowest bale.

BASIS OF PAYMENT: Straw or hay bale installation shall be paid for under Item 207, Straw or Hay Bales.

Cost will include placing, staking, maintaining and removing.

Sediment pit, 0.5 m max. depth with sand and gravel outlet filter, 0.3 m min. height

DIKES AND SLOPE PROTECTION

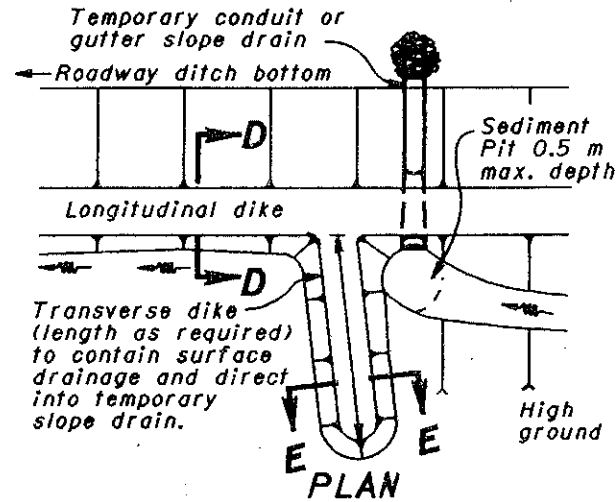

PLAN

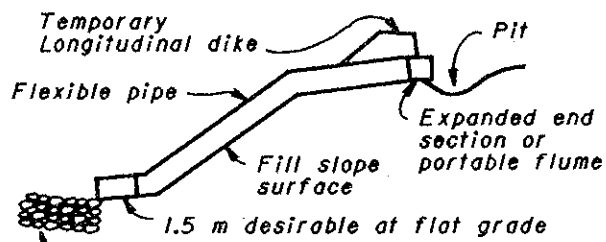

CONDUIT SLOPE DRAIN

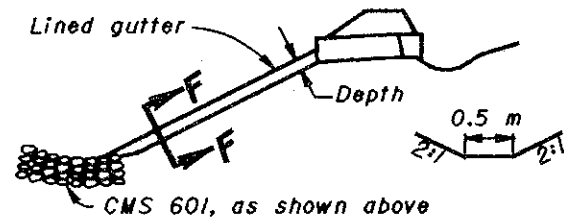

SECTION F-F
GUTTER SLOPE DRAIN

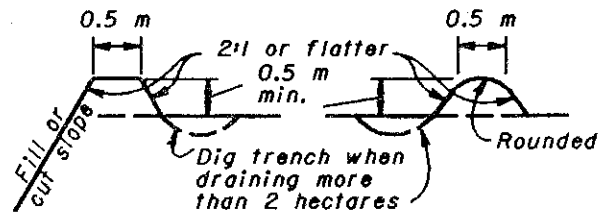

SECTION D-D

SECTION E-E

GENERAL: Dikes & drains shown shall be used when earthwork operations on slopes higher than 2.5 m are suspended for three weeks or more and/or as directed by the Engineer. Smaller dikes used at the end of a day's operation shall be considered as part of the earthwork. Temporary slope drains shall be suitably positioned and anchored to prevent movement or undermining, as directed by the Engineer.

LONGITUDINAL DIKES: shall be constructed of suitable material as per CMS 203 and compacted to 85% maximum density.

CONDUITS: Conduits for slope drains shall be corrugated steel pipe, corrugated or smooth plastic pipe, rubber conduit, or an approved equal.

GUTTERS: Gutters for slope drains shall be lined with Type C rock channel protection, crushed aggregate slope protection, portland cement concrete, bituminous concrete, plastic sheeting (on slopes 4:1 max.), partial pipe sections or approved equal.

PITS: Sediment pits shall be provided where directed by the Engineer and their cost included in the price bid for adjacent CMS 207 items.

BASIS OF PAYMENT: Temporary dikes shall be paid for under Item 207, Temporary Dikes.

Temporary slope drains shall be paid for under Item 207, Temporary Slope Drains. Rock required shall be paid for under Item 601, Rock Channel Protection, Type C, w/o Filter.

TEMPORARY SLOPE DRAINS RECOMMENDED SIZES

Area (hectares)	Pipe Sizes (mm)			Gutter depth (mm)
	Smooth	Corrugated	Half-round	
0-1.6	150	150	450	200
1.6-3.2	200	300	450	200
3.2-4.9	250	375	525	300

SEDIMENT BASINS & DAMS

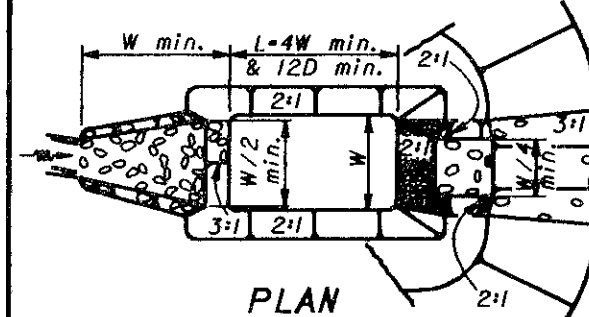

PLAN

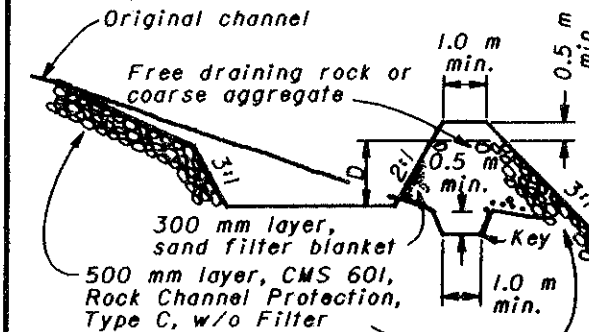

PROFILE
SEDIMENT DAM

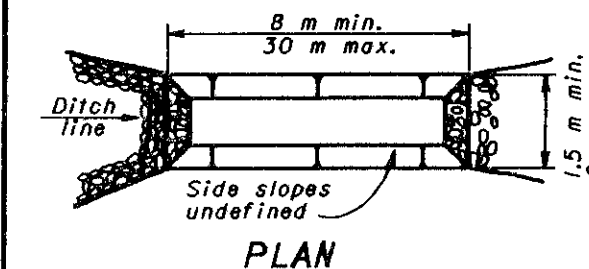

PLAN

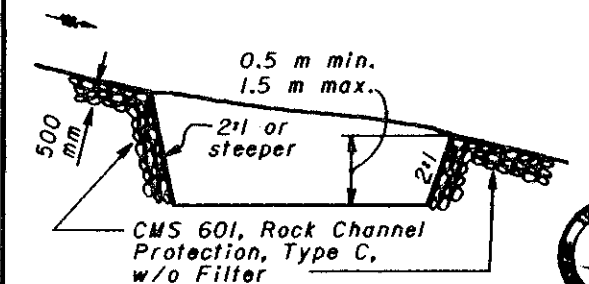

PROFILE
SEDIMENT BASIN

EMBANKMENT: Sediment basin embankment construction shall be as per CMS 203 compacted as directed by the Engineer.

MAINTENANCE: Sediment pits, dams and basins shall be acceptably maintained. Deposited sediment shall be removed when the initial volume has been reduced one-half.

The sand filter blanket on sediment basins shall be replaced when deposited sediment is removed. The cost of maintenance shall be included in the unit price bid for the appropriate CMS 207 item.

FILTERS: Plastic filter fabric, as approved by the Engineer, may be substituted for the sand filter blanket on sediment dams. Such fabrics may be cleaned in lieu of replacement, when approved by the Engineer.

SIZE: The volume shown on the plans is the total storage volume required for the sediment basin or dam. A series of smaller basins or dams may be substituted for a larger basin or dam when approved by the Engineer.

BASIS OF PAYMENT: Sediment Dams and Basins shall be paid for under Item 207, Temporary Benches, Dams and Sediment Basins. The pay quantity shall be the actual number of cubic meters of excavation and embankment required to construct the basin or dam. Rock required shall be paid for under Item 601, Rock Channel Protection, Type C, w/o Filter.



This Drawing Replaces MC-11.

BUREAU OF LOCATION AND DESIGN
OHIO DEPARTMENT OF TRANSPORTATION

TEMPORARY
EROSION
CONTROL

DATE
6-30-95

STANDARD
CONSTRUCTION
DRAWING

DM-4.3M

APPROVED

W.K. Hubman

ENGR. L & D