

CENTERLINE SURVEY PLAT
FOR
S.R. 306 a.k.a. REYNOLDS ROAD
CITY OF MENTOR, LAKE COUNTY, OHIO

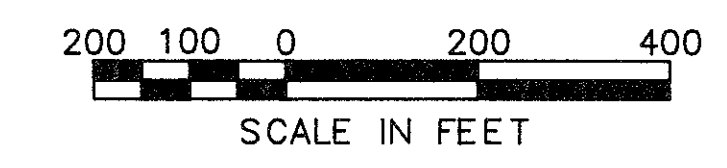

I HEREBY CERTIFY THAT THIS PLAT IS A TRUE DELINEATION OF A SURVEY FOR THE CITY OF MENTOR.

CT CONSULTANTS, INC.
BY _____
RICHARD J. BILSKI
REGISTERED SURVEYOR No. 5244
DATE _____

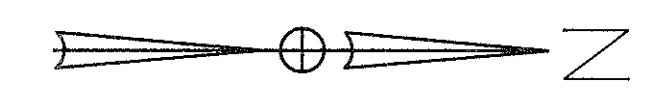
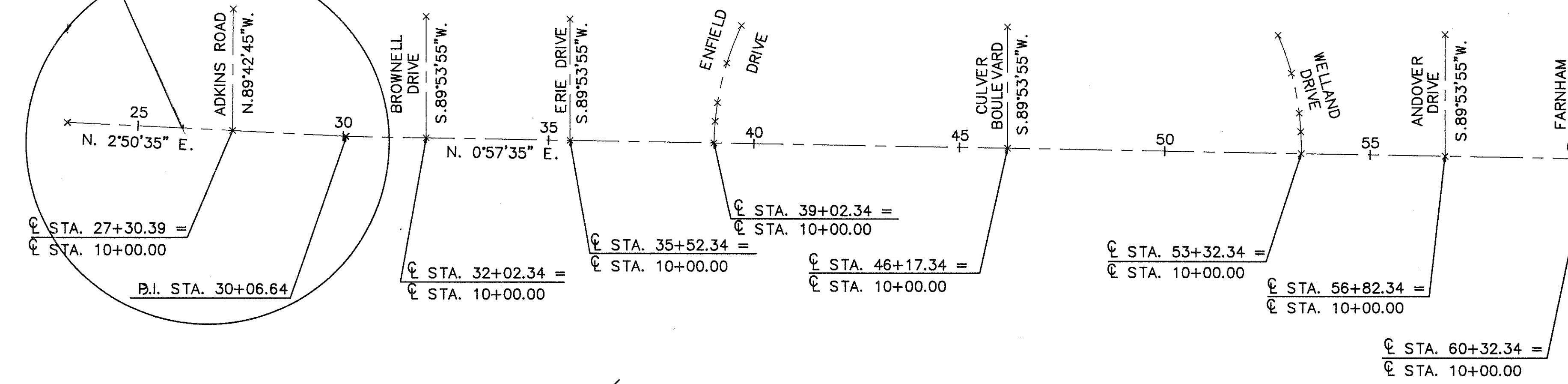
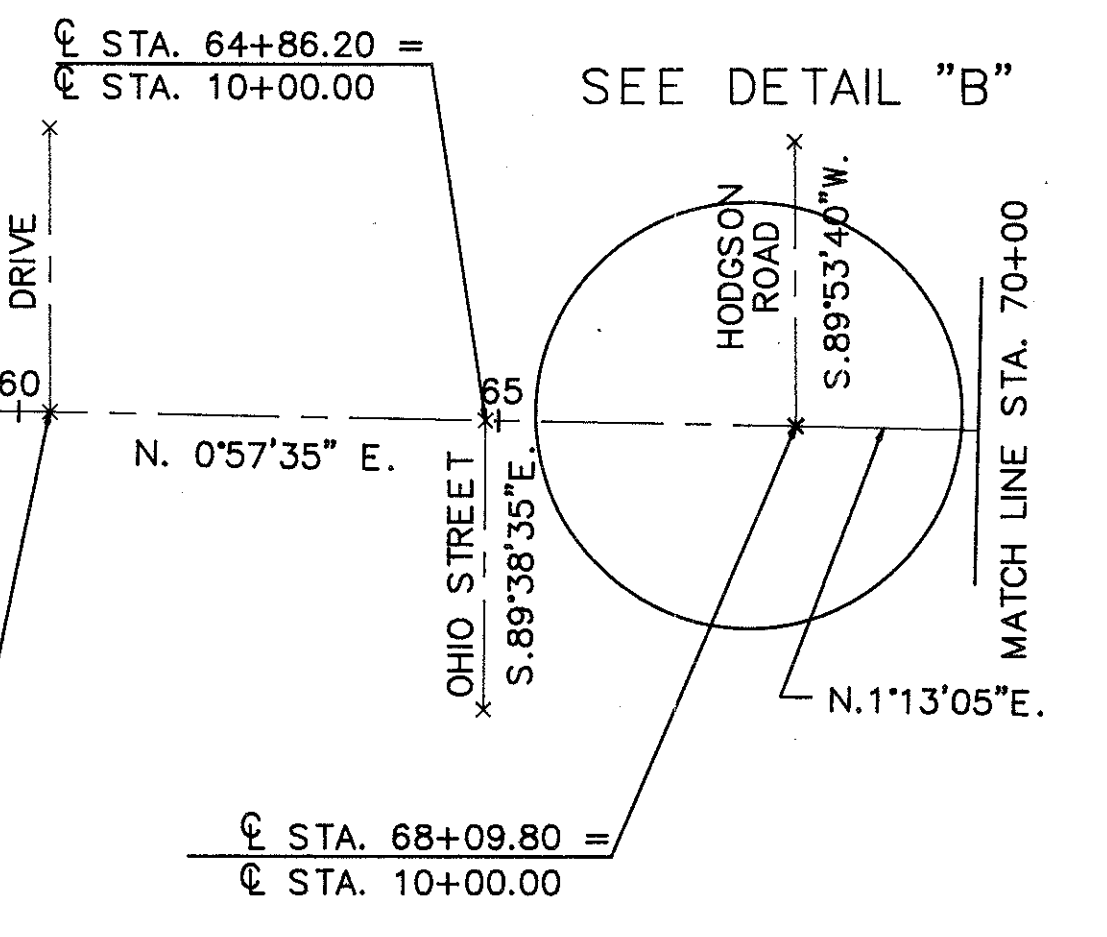
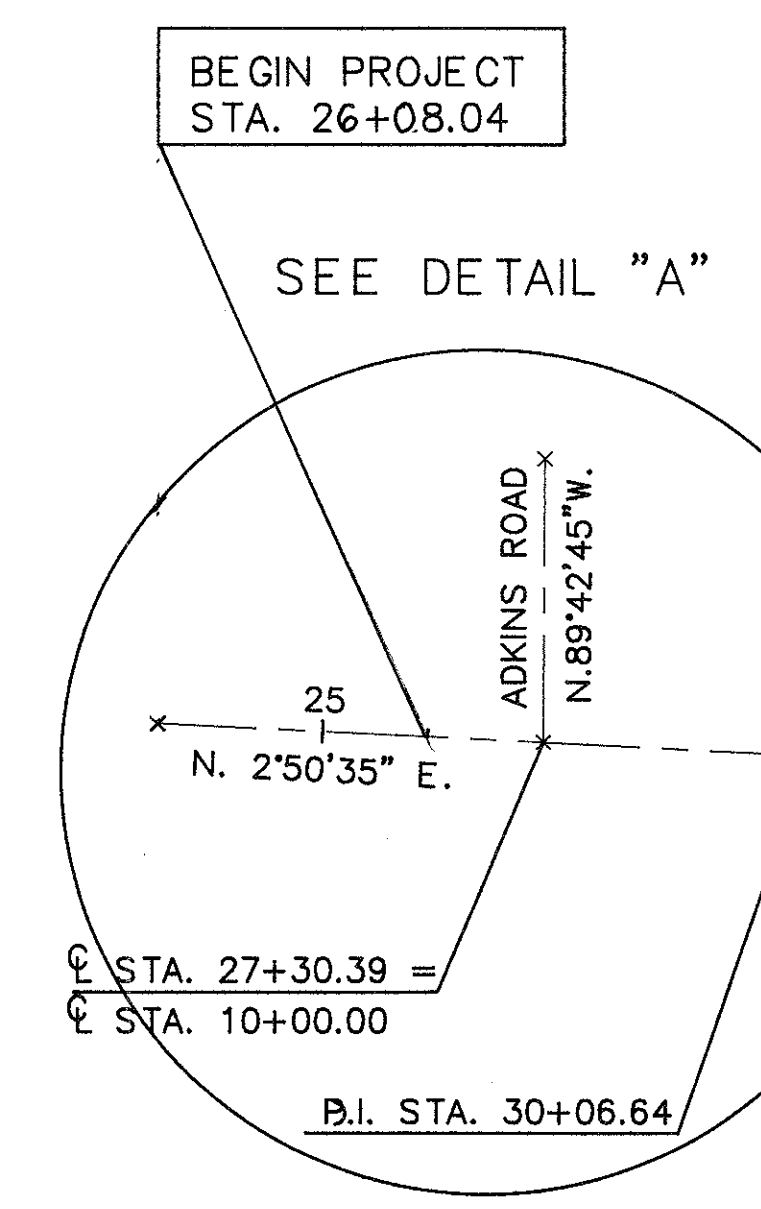
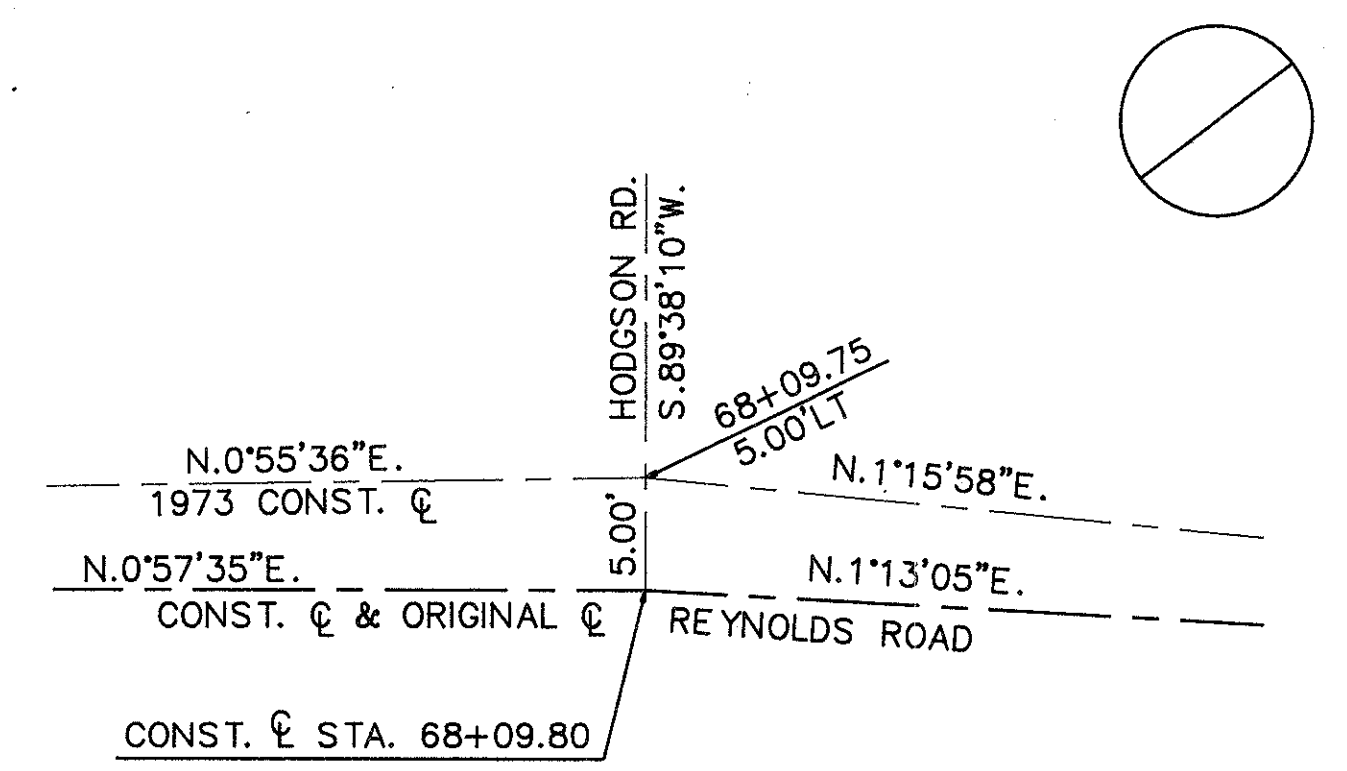

CENTERLINE MONUMENT ASSEMBLIES	
STATION	REMARKS
27+30.39	CL ADKINS ROAD
30+06.64	P.I.
32+02.34	CL BROWNELL DR.
35+52.34	CL ERIE DRIVE
39+02.34	CL ENFIELD DR.
46+17.34	CL CULVER BLVD.
53+32.34	CL WELLAND DR.
56+82.34	CL ANDOVER DR.
60+32.34	CL FARNHAM DR.
64+86.20	CL OHIO STREET
68+09.80	CL HODGSON RD.

CENTERLINE MONUMENT ASSEMBLIES WILL BE PLACED AT THE DIRECTION OF THE FIELD ENGINEER AT THE FOLLOWING LOCATIONS.

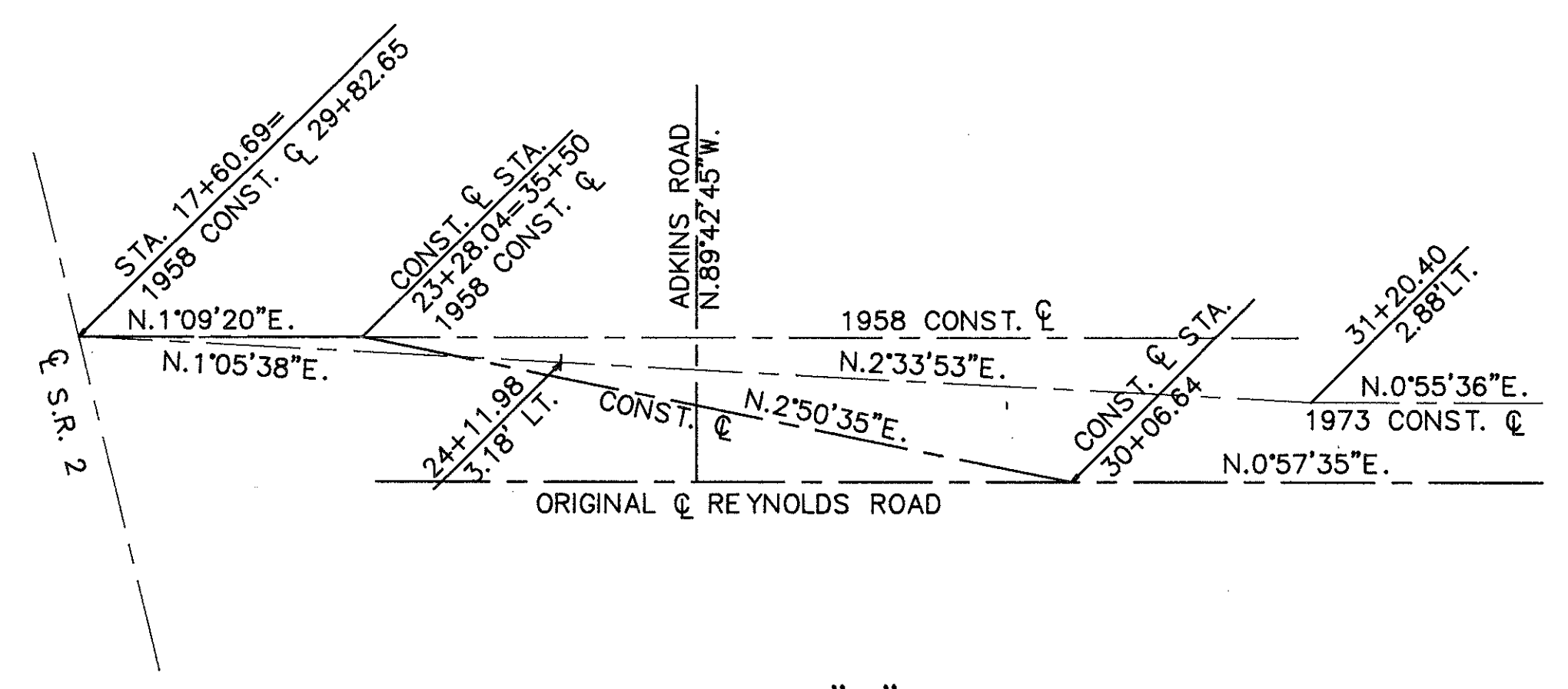

RECEIVED FOR RECORD THIS _____ DAY OF _____, 19____
RECORDED IN VOLUME _____ PAGE _____ OF THE
LAKE COUNTY RECORD OF PLATS.
RECORDER _____

CERTIFICATE OF APPROVAL:
SIGNED BY: _____ MENTOR CITY ENGINEER
DATE: _____