

625, POWER SERVICE, AS PER PLAN (CONT.)

THE ENGINEER SHALL ENSURE THAT EACH POWER SERVICE ELECTRICAL ENERGY ACCOUNT IS IN THE NAME OF AND THAT THE BILLING ADDRESS IS TO THE MAINTAINING AGENCY NOTED IN THE PLANS. THIS SHALL BE DONE NOT ONLY FOR EACH NEW POWER SERVICE ESTABLISHED BY THIS PROJECT BUT ALSO FOR EACH EXISTING POWER SERVICE, SINCE THERE MAY BE A RE-ASSIGNMENT OF THE RESPONSIBILITY FOR AN EXISTING SERVICE AS A RESULT OF THE WORK PERFORMED BY THIS PROJECT.

PAYMENT WILL BE MADE AT THE UNIT BID PRICE FOR EACH CMS ITEM 625, "POWER SERVICE, AS PER PLAN" WHICH SHALL BE FULL COMPENSATION FOR ALL LABOR, MATERIALS AND INCIDENTALS REQUIRED TO COMPLETE THIS ITEM IN A SATISFACTORY AND WORKMANLIKE MANNER.

PADLOCKS AND KEYS

PADLOCKS FURNISHED SHALL BE EITHER BRASS OR BRONZE, EQUAL TO MASTER NO. 4BKA OR WILSON BOHANNAN 660A, AND SHALL BE KEYED IN ACCORDANCE WITH CMS 631.06. PAYMENT SHALL BE INCLUDED IN THE BID FOR THE ITEM(S) BEING LOCKED.

SPECIAL, MAINTAIN EXISTING LIGHTING

EXISTING ROADWAYS WHICH ARE TO REMAIN OPEN TO TRAFFIC DURING CONSTRUCTION OF THIS PROJECT AND WHICH ARE LIGHTED SHALL HAVE THE LIGHTING MAINTAINED AS DESCRIBED HEREIN.

BEFORE ANY WORK IS STARTED IN THE IMMEDIATE VICINITY OF THE EXISTING LIGHTING CIRCUITS, REPRESENTATIVES OF ODOT, THE MAINTAINING AGENCY AND THE CONTRACTOR SHALL MAKE A VISUAL INSPECTION OF THE EXISTING ROADWAY LIGHTING CIRCUITS TO BE MAINTAINED. DURING THIS INSPECTION, A WRITTEN RECORD OF THE CONDITION OF EXISTING LIGHTING SHALL BE MADE BY ODOT'S REPRESENTATIVE. THIS WRITTEN REPORT SHALL NOTE INDIVIDUAL LUMINAIRES WHICH ARE NOT IN WORKING ORDER, INDIVIDUAL POLES WHICH ARE STANDING, AND INDIVIDUAL CIRCUITS WHICH ARE NOT IN WORKING ORDER. THE COMPLETED REPORT SHALL BE SIGNED BY THE REPRESENTATIVES OF ODOT, THE MAINTAINING AGENCY AND THE CONTRACTOR.

IF, AS A RESULT OF THIS INSPECTION, IT IS DETERMINED THAT THE CONDITION OF THE EXISTING SYSTEM IS BELOW THAT REQUIRED FOR THE SAFETY OF THE TRAVELING PUBLIC, THEN THE MAINTAINING AGENCY SHALL MAKE THE REPAIRS NECESSARY TO RETURN THE SYSTEM TO AN ACCEPTABLE CONDITION. FOLLOWING THESE REPAIRS, THE SYSTEM SHALL AGAIN BE INSPECTED AND A REPORT SHALL BE MADE AND SIGNED AS OUTLINED HEREIN.

WHEN THE EXISTING SYSTEM IS IN AN ACCEPTABLE CONDITION, IT SHALL BE TURNED OVER TO THE CONTRACTOR WHO SHALL THEN BE REQUIRED TO MAINTAIN THE EXISTING LIGHTING TO THE CONDITION OUTLINED IN THIS REPORT WITH THE EXCEPTION OF KNOCKDOWNS DUE TO TRAFFIC ACCIDENTS.

REPLACEMENT OF KNOCKED DOWN UNITS SHALL BE DONE ONLY WHEN THE ENGINEER HAS DETERMINED THAT THE REPLACEMENT OF THE KNOCKED DOWN UNIT IS NECESSARY AND SHALL BE PAID SEPARATELY ON A UNIT BASIS.

BETTERMENTS SHALL BE COVERED IN ITEMS OF WORK PERTAINING TO THE CONSTRUCTION OF PERMANENT IMPROVEMENT.

SPECIAL, MAINTAIN EXISTING LIGHTING (CONT.)

WHEN THE SEQUENCE OF CONSTRUCTION ACTIVITIES REQUIRES, OR SHOULD THE CONTRACTOR DESIRE, THE REMOVAL OF THE EXISTING LIGHTING BEFORE THE NEW LIGHTING IS OPERATIONAL, THE CONTRACTOR SHALL BE RESPONSIBLE FOR PROVIDING TEMPORARY LIGHTING OF THIS PORTION OF THE ROADWAY.

PRIOR TO INSTALLING SUCH LIGHTING, THE CONTRACTOR SHALL PREPARE AND SUBMIT FOUR SETS OF THE TEMPORARY LIGHTING PLAN TO THE ENGINEER FOR REVIEW AND APPROVAL.

THIS PLAN SHALL SHOW LOCATIONS OF POLES, LENGTHS OF BRACKET ARMS, STYLES OF LUMINAIRES, MOUNTING HEIGHTS, WIRING METHODS AND OTHER PERTINENT INFORMATION. THE TEMPORARY LIGHTING SHALL PROVIDE AN AVERAGE INITIAL INTENSITY OF 1.2 FOOTCANDLES WITH AN AVERAGE TO MINIMUM UNIFORMITY NOT TO EXCEED 3:1. MOUNTING HEIGHT OF TEMPORARY LUMINAIRES SHALL NOT BE LESS THAN 30 FEET, AND THE MINIMUM OVERHEAD CONDUCTOR CLEARANCE SHALL BE 20 FEET. TEMPORARY OVERHEAD CONSTRUCTION SHALL NOT BE LESS THAN GRADE "A" FOR STRENGTH REQUIREMENTS AS DEFINED BY THE NATIONAL ELECTRIC SAFETY CODE. WOOD POLES WITH OVERHEAD WIRING MAY BE USED. HOWEVER, TEMPORARY LIGHTING SHALL MEET FEDERAL AND STATE SAFETY CRITERIA. IF BREAKAWAY POLES ARE USED TO MEET THESE CRITERIA, THEN UNDERGROUND WIRING SHALL BE USED. RE-CONDITIONED OR USED MATERIALS MAY BE FURNISHED FOR TEMPORARY LIGHTING.

ALL MATERIALS NECESSARY TO COMPLETE THE TEMPORARY LIGHTING SHALL BE FURNISHED AND INSTALLED BY THE CONTRACTOR. WHEN NO LONGER NEEDED, THE TEMPORARY LIGHTING INSTALLATION SHALL BE REMOVED AND PROPERLY DISPOSED OF BY THE CONTRACTOR.

THE MAINTAINING AGENCY WILL PAY FOR ELECTRICAL ENERGY CONSUMED BY EXISTING POWER SERVICES AND BY PROPOSED PERMANENT POWER SERVICES AFTER ACCEPTANCE OF THE LIGHTING WORK. THE CONTRACTOR WILL PAY FOR ELECTRICAL ENERGY, INSTALLATION, REMOVAL AND MAINTENANCE OF ANY TEMPORARY POWER SERVICES.

THE LUMP SUM PRICE BID FOR ITEM SPECIAL "MAINTAIN EXISTING LIGHTING" SHALL INCLUDE PAYMENT FOR ALL LABOR, EQUIPMENT, MATERIALS AND INCIDENTALS NECESSARY TO MAINTAIN THE EXISTING LIGHTING AS SPECIFIED HEREIN.

THE UNIT PRICE BID FOR ITEM SPECIAL "REPLACEMENT OF EXISTING LIGHTING UNIT" SHALL BE FULL PAYMENT FOR THE REPLACEMENT OF AN EXISTING LIGHTING UNIT WHICH HAS BEEN KNOCKED DOWN AFTER THE AFOREMENTIONED INSPECTION AND SHALL INCLUDE ALL LABOR, EQUIPMENT, MATERIALS AND INCIDENTALS NECESSARY TO PROVIDE A REPLACEMENT FOR SUCH UNIT.

ABANDONING OF EXISTING CONDUIT AND DUCT CABLE

UNLESS OTHERWISE NOTED IN THE PLANS, THE EXISTING CONDUIT AND DUCT CABLE SHALL BE ABANDONED IN PLACE. NO PAYMENT WILL BE MADE FOR THIS ITEM.

EXISTING LIGHTING

UNLESS OTHERWISE NOTED IN THE PLANS, THE EXISTING HIGH MAST LIGHTING WITHIN THE PROJECT LIMITS SHALL BE REMOVED.

625 - LIGHTING MISC.: UNDERPASS LIGHTING SYSTEM

IN ADDITION TO THE REQUIREMENTS OF ODOT'S CONSTRUCTION AND MATERIAL SPECIFICATIONS, THIS ITEM SHALL INCLUDE THE FOLLOWING:

"LIGHTING MISC.: UNDERPASS LIGHTING SYSTEM" SHALL INCLUDE, BUT IS NOT NECESSARILY LIMITED TO: ALL ELECTRICAL EQUIPMENT, SUCH AS UNDERPASS LUMINAIRES, RIGID CONDUIT, CONDUIT SUPPORTS, ETC. TO COMPLETE ENTIRE LIGHTING SYSTEM CONNECTED TO SERVICE TO UNDERPASS LIGHTING.

THE LUMP SUM PRICE BID FOR "LIGHTING MISC.: UNDERPASS LIGHTING SYSTEM" SHALL BE FULL PAYMENT FOR ALL LABOR, MATERIALS, AND INCIDENTALS REQUIRED TO COMPLETE THIS ITEM IN A SATISFACTORY AND WORKMANLIKE MANNER.

SERVICE TO UNDERPASS LIGHTING, AS PER PLAN

IN ADDITION TO THE REQUIREMENTS OF ODOT'S CONSTRUCTION AND MATERIAL SPECIFICATIONS, THIS ITEM SHALL INCLUDE THE FOLLOWING:

"SERVICE TO UNDERPASS LIGHTING, AS PER PLAN" SHALL INCLUDE, BUT IS NOT NECESSARILY LIMITED TO: POLES OR OTHER SUPPORT STRUCTURE FOR MOUNTING OF EQUIPMENT, TRENCH AND CONDUIT FOR UNDERGROUND SERVICE, METER BASE, CUSTOMER SERVICE DISCONNECT, MECHANICALLY HELD LIGHTING CONTRACTOR, PHOTOELECTRIC CELL AND H-O-A SWITCH FOR CONTROL, OVERCURRENT PROTECTION, ENCLOSURES, CONDUIT, FITTINGS, CABLES, CONNECTORS, AND CONDUIT RISER AT UTILITY POLE.

PAYMENT WILL BE MADE AT THE UNIT BID PRICE FOR EACH CMS ITEM 625, "SERVICE TO UNDERPASS, AS PER PLAN" WHICH SHALL BE FULL COMPENSATION FOR ALL LABOR, MATERIALS AND INCIDENTALS REQUIRED TO COMPLETE THIS ITEM IN A SATISFACTORY AND WORKMANLIKE MANNER.











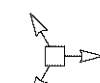



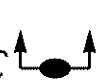

LIGHT POLE, DECORATIVE, AS PER PLAN

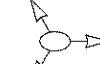
IN ADDITION TO THE REQUIREMENTS OF ODOT'S CONSTRUCTION AND MATERIAL SPECIFICATIONS, DECORATIVE LIGHT POLES SHALL INCLUDE THE FOLLOWING:

DECORATIVE LIGHT POLES SHALL BE DESIGN AON12, BLACK FIBERGLASS, WITH FLUTED TAPERED SHAFT AND 4.5" POST TOP, WITH A 0.20" PER FOOT TAPER. A 3" O.D. X 3" LONG GALVANIZED STEEL TENON SHALL BE PROVIDED FOR LUMINAIRE TO POST TOP MOUNTING. A HANDHOLE SHALL BE PROVIDED, WITH COLOR TO MATCH POST. DECORATIVE LIGHT POLES SHALL BE VALMONT W.J. WHATLEY, INC. "XF45-D9M", OR EQUAL APPROVED BY THE ENGINEER.

PAYMENT WILL BE MADE AT THE UNIT BID PRICE UNDER CMS ITEM 625, "LIGHT POLE, DECORATIVE, AS PER PLAN" FOR EACH DECORATIVE LIGHT POLE WHICH SHALL BE FULL COMPENSATION FOR ALL LABOR, MATERIALS, AND INCIDENTALS REQUIRED TO COMPLETE THIS ITEM IN A SATISFACTORY AND WORKMANLIKE MANNER.

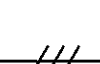
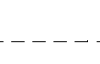
SYMBOL LEGEND

-  EXISTING HIGH MAST LUMINAIRE
-  EXISTING LIGHT POLE
-  LOW MAST GALVANIZED STEEL POLE WITH 1-400W SYMMETRIC LUMINAIRE PER 725.11, MOUNTED ON CONCRETE MEDIAN, UNLESS OTHERWISE NOTED
-  LOW MAST GALVANIZED STEEL POLE WITH 1-400W TYPE II ASYMMETRIC LUMINAIRE PER 725.11
-  LOW MAST GALVANIZED STEEL POLE WITH 1-400W TYPE III ASYMMETRIC LUMINAIRE PER 725.11, MOUNTED ON BRIDGE PARAPET
-  LOW MAST GALVANIZED STEEL POLE WITH 1-400W TYPE II ASYMMETRIC LUMINAIRE PER 725.11, MOUNTED ON BRIDGE PARAPET
-  EXISTING PULL BOX
-  PROPOSED PULL BOX
-  EXISTING CONDUIT
-  PROPOSED CONDUIT, 3", JACKED OR DRILLED UNDER PAVEMENT
-  EXISTING LOW MAST POLE WITH SYMMETRIC LUMINAIRE
-  EXISTING UNDERPASS LUMINAIRE
-  PROPOSED 100W HPS UNDERPASS LUMINAIRE
-  EXISTING POWER SERVICE
-  PROPOSED POWER SERVICE
-  PROPOSED POST TOP LUMINAIRE AND FIBERGLASS POLE, WITH 1-150W TYPE III ASYMMETRIC LUMINAIRE PER 725.11, WITH BLACK FINISH.
-  PROPOSED CIRCUITING, SEE PLANS FOR CIRCUIT SIZES AND NUMBER OF SETS.
-  EXISTING CIRCUITING, SEE PLANS FOR SIZES
-  CONVENTIONAL LUMINAIRE WITH 1-400W, 120V TYPE II ASYMMETRIC LUMINAIRE PER 725.11, AND INTEGRAL PHOTOCCELL, MOUNTED ON COMBINATION TRAFFIC POLE.
-  TRANSITION JUNCTION BOX PER HL-30.33

LIGHT POLE IDENTIFICATION

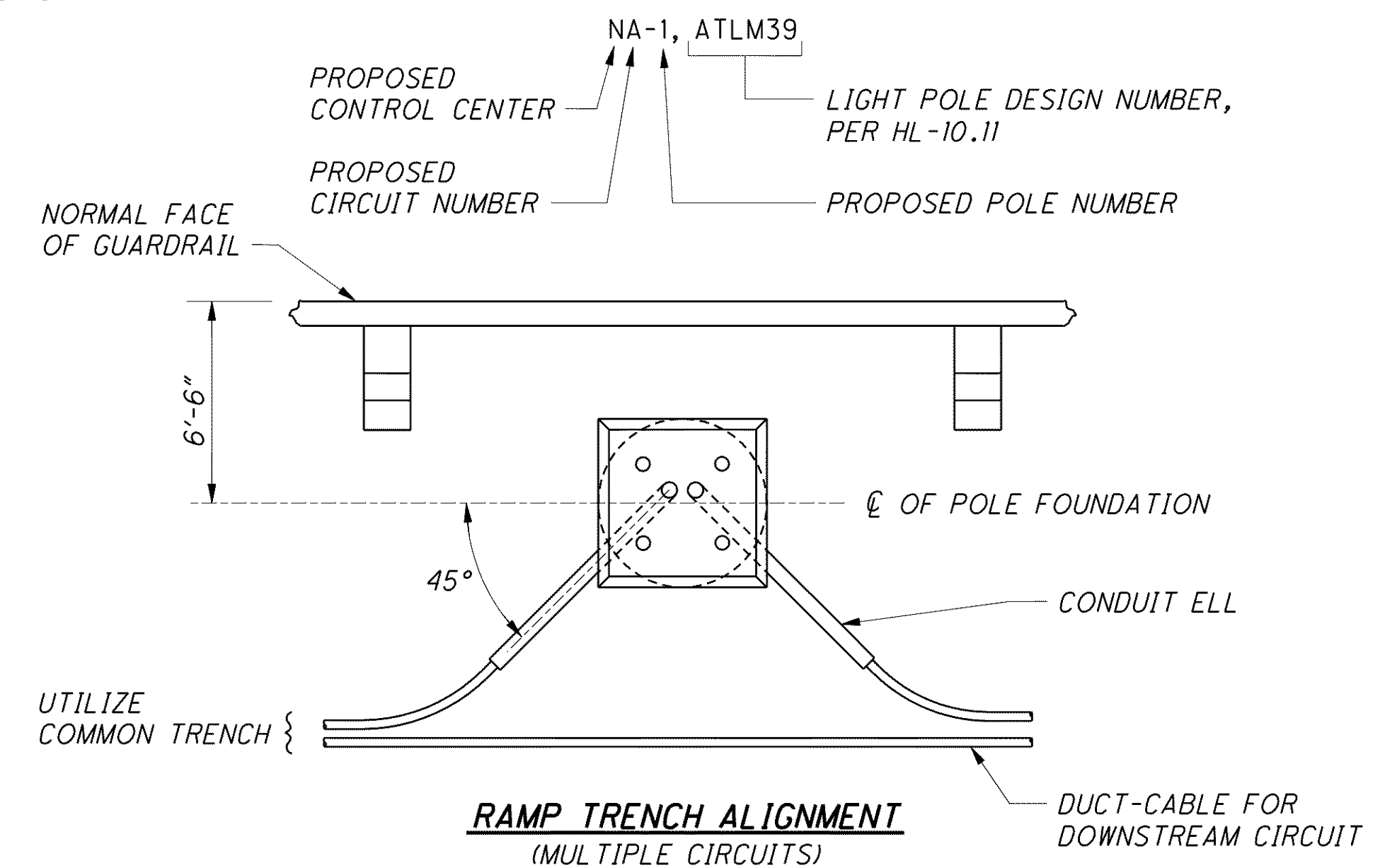

RAMP TRENCH ALIGNMENT (MULTIPLE CIRCUITS)

g:\project\lak\13486\lighting\sheets\13486.LN002.dgn 7/11/2008 8:46:48 AM cshaner