

FIGURE 1
TYPICAL LOOP SLOT CONSTRUCTION

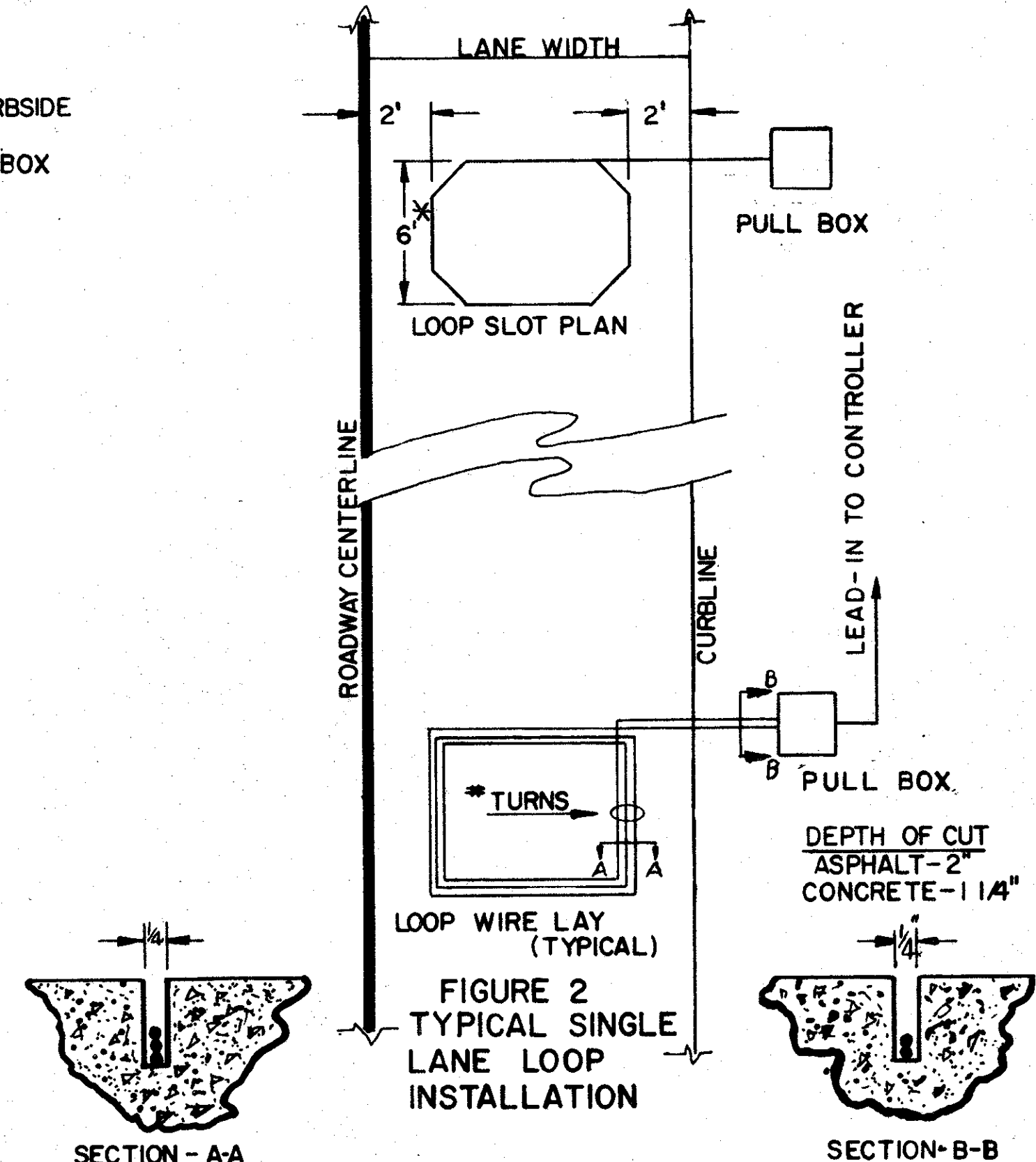

FIGURE 2
TYPICAL SINGLE LANE LOOP INSTALLATION

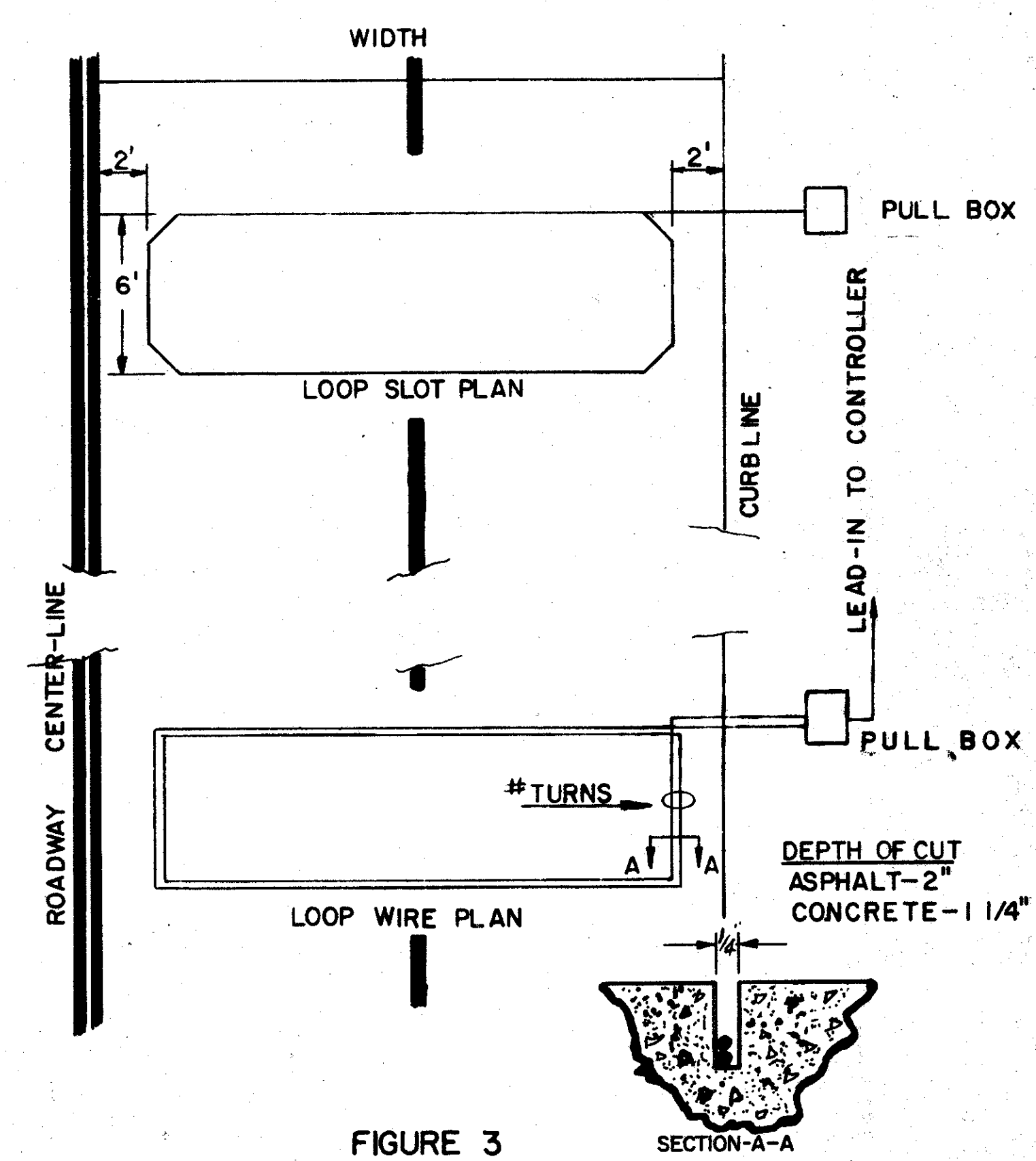

FIGURE 3
TYPICAL TWO LANE LOOP INSTALLATION

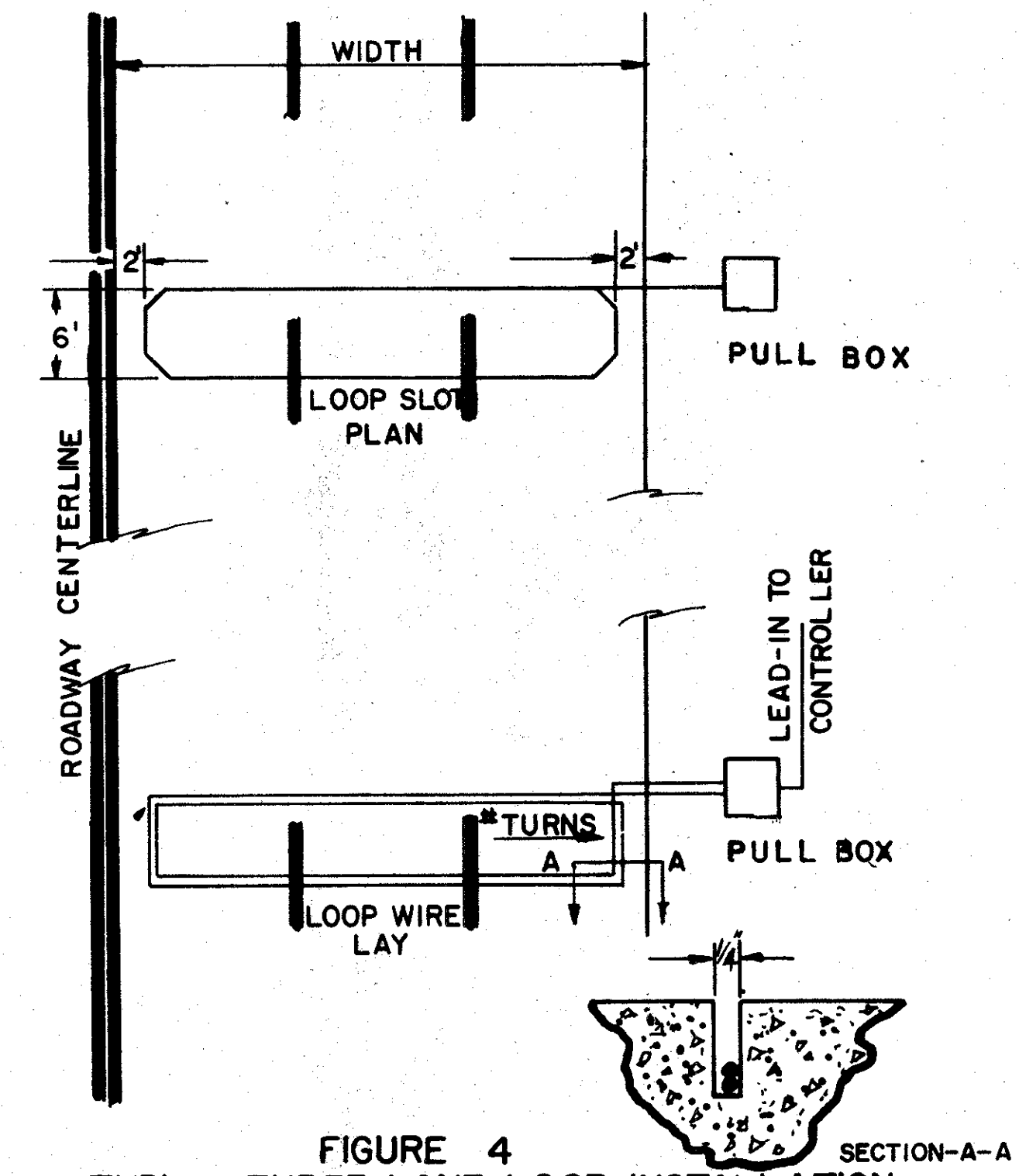
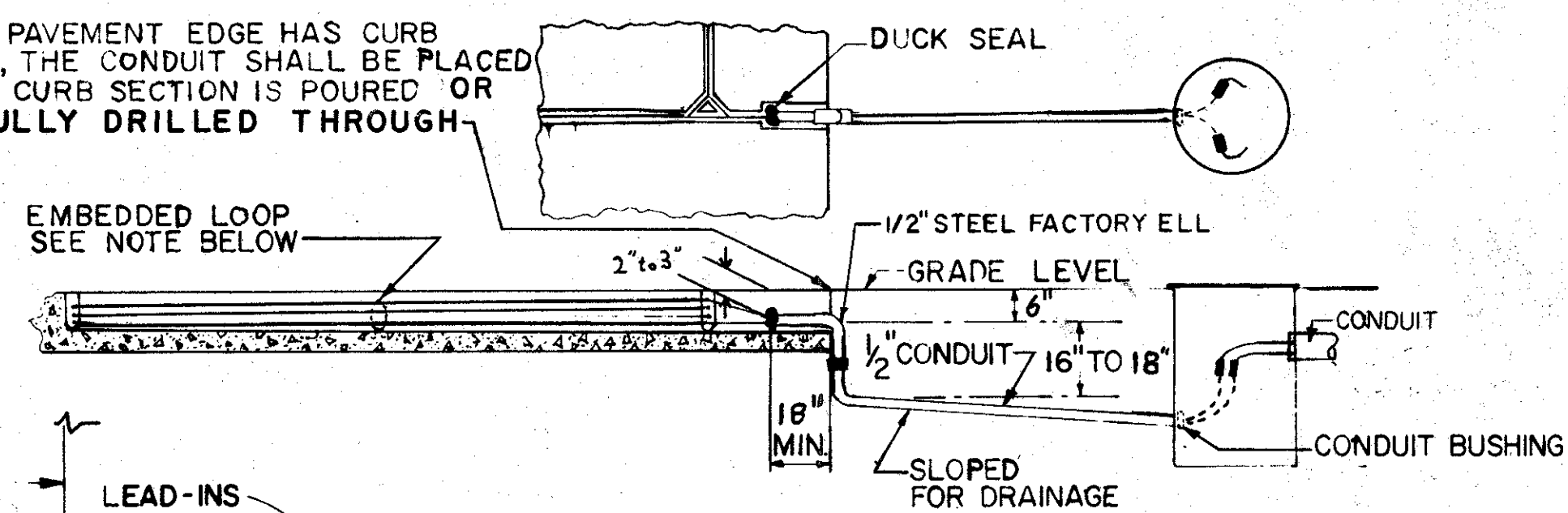

FIGURE 4
TYPICAL THREE LANE LOOP INSTALLATION

TABLE-1 ROADWAY LOOP CONSTRUCTION	
LOOP PERIMETER	NO. OF TURNS
UP TO 40 FEET	3
40 TO 160 FEET	2
160 AND UP	1
MAINTAIN 6' MINIMUM DIMENSION IN DIRECTION OF TRAVEL.	

WHERE PAVEMENT EDGE HAS CURB SECTION, THE CONDUIT SHALL BE PLACED BEFORE CURB SECTION IS POURED OR CAREFULLY DRILLED THROUGH CURB



NOTE: IT IS EXTREMELY IMPORTANT THAT THE SAWSLOT BE THOROUGHLY CLEANED AND COMPLETELY DRY BEFORE APPLYING SLOT SEALER

SPLICE TO LEAD IN CABLE BY SOLDERING AND APPLYING WATERPROOF SPLICING KIT

FIGURE 8
INTERFACE BETWEEN EMBEDDED LOOP AND ROAD SIDE PULL BOX

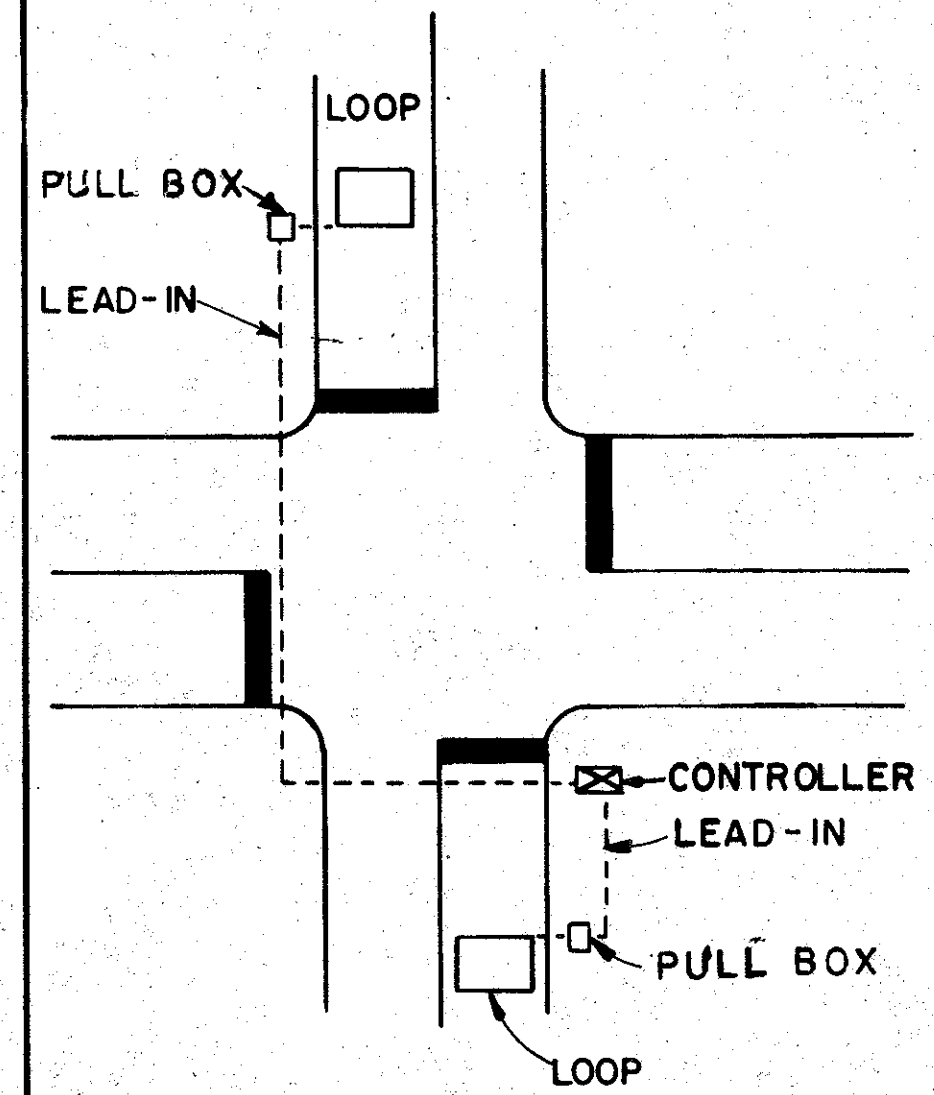

FIGURE 5
TYPICAL LEAD-IN DETAIL

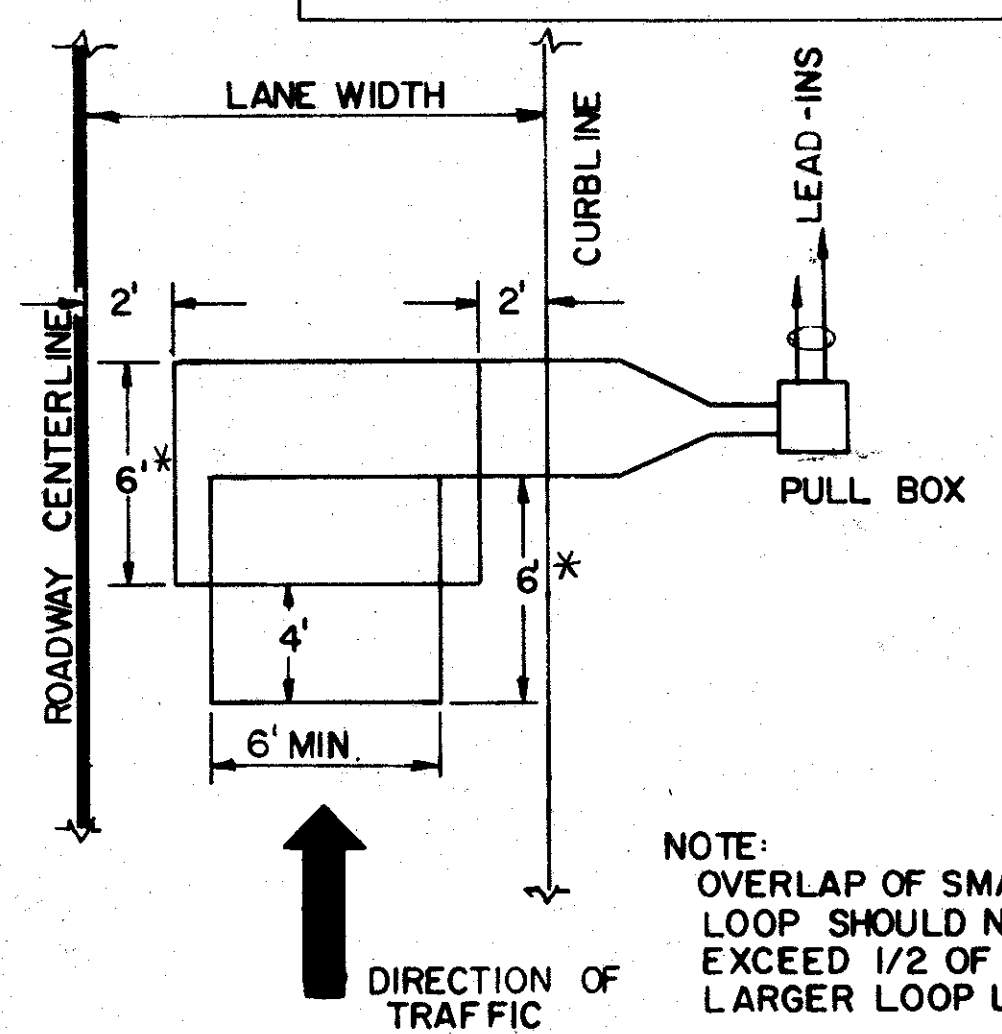

FIGURE 6
TYPICAL DIRECTIONAL DETECTION LOOP INSTALLATION (OVERLAPPED)

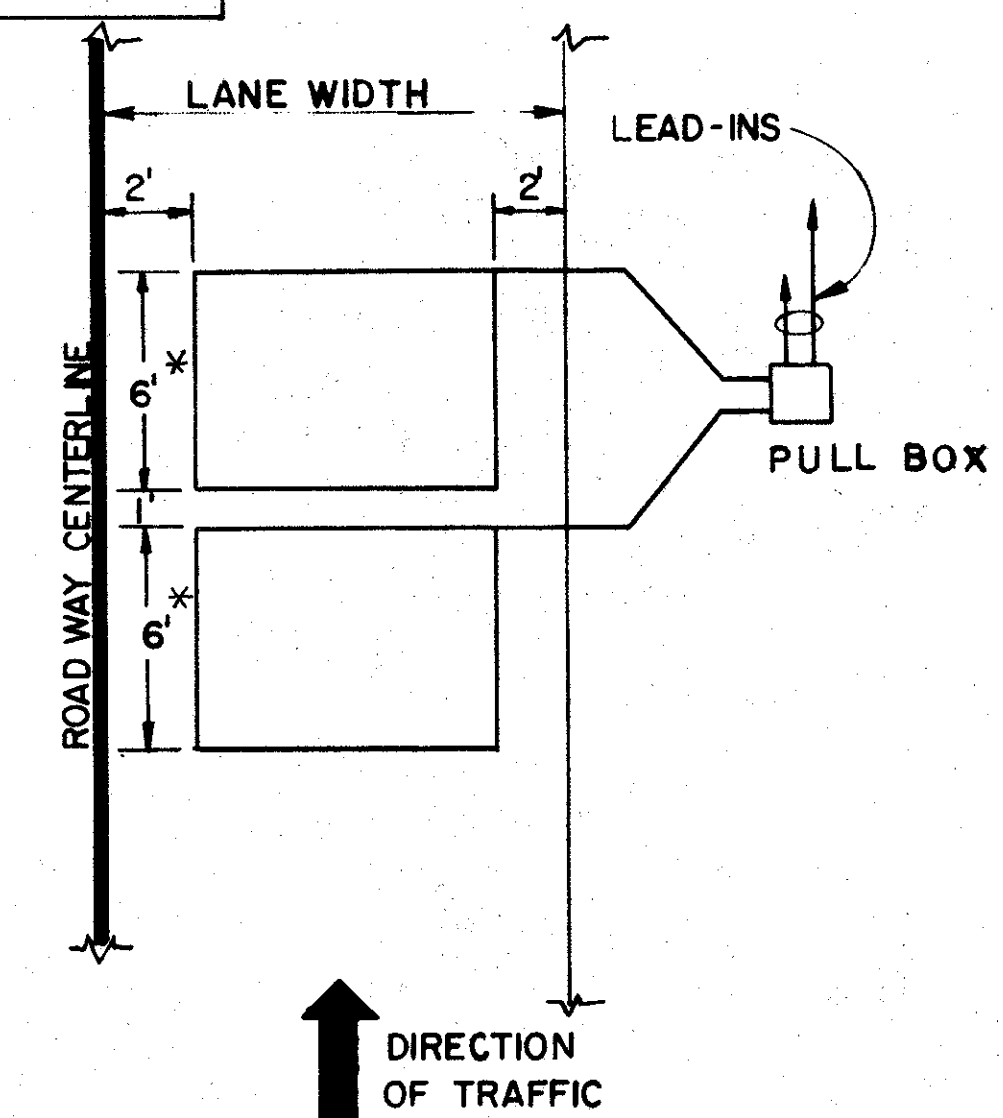

FIGURE 7
TYPICAL DIRECTIONAL DETECTION LOOP INSTALLATION (ADJACENT)

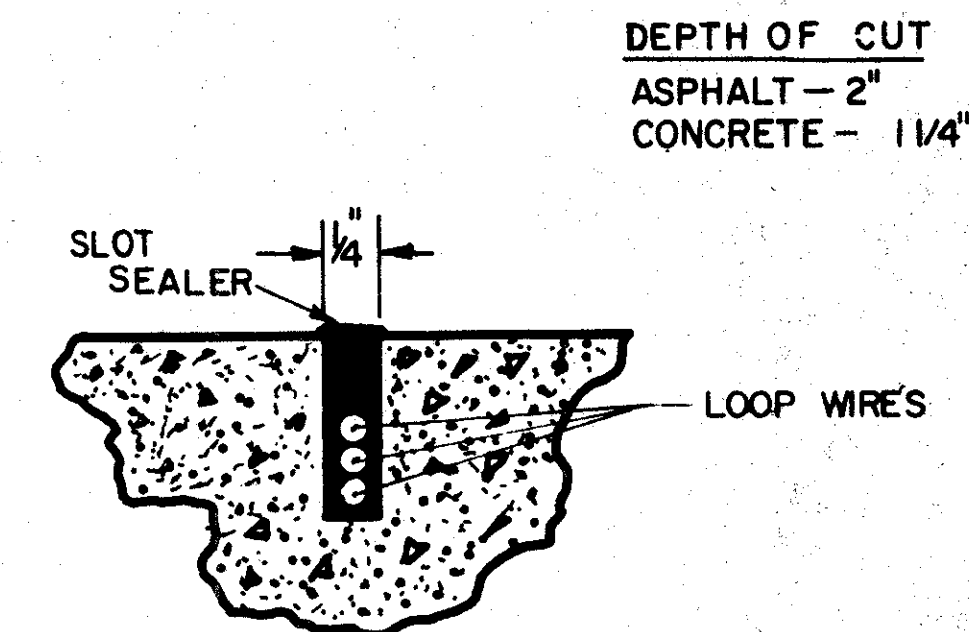

FIGURE 9
TYPICAL SLOT SEALING DETAIL

ROADWAY LOOP INSTALLATION

THE ROADWAY WIRE LOOP IS POSITIONED IN THE PAVEMENT IN A SAWSLOT THAT OUTLINES THE REQUIRED DETECTION AREA. THE SLOT SHALL BE 1/4" WIDE AND FROM 1/4" OR 2" DEEP. RIGHT ANGLE TURNS SHALL BE CHAMFERED TO PREVENT SHARP BENDS OF WIRE (SEE FIG. 1). THE SLOT MUST BE BRUSHED AND BLOWN CLEAN OF ALL LOOSE MATERIAL. THE LOOP WIRE MUST BE CAREFULLY PUSHED INTO THE SLOT WITH A BLUNT STICK TO AVOID DAMAGING ITS INSULATION. RESISTANCE OF THE WIRE LOOP TO GROUND SHOULD BE CHECKED AFTER THE WIRE IS PLACED IN THE SLOT, BOTH BEFORE AND AFTER THE SLOT IS SEALED. THIS IS ESPECIALLY IMPORTANT IF THE ROADWAY WIRE LOOP IS SPLICED TO LEAD-IN CABLE AT CURBSIDE JUNCTION BOX. A RESISTANCE OF LESS THAN 10 MEGOHMS INDICATES A FAULTY SPLICE OR WIRE INSTALLATION WHICH MUST BE CORRECTED BEFORE THE ROADWAY LOOP IS SEALED IN PLACE. INSTALLATIONS IN NEW ASPHALT PAVEMENT SHALL BE MADE IN THE SUBBASE PRIOR TO PLACING THE TOP COURSE.

SEALING

A FLEXIBLE EMBEDDING SEALANT NO. 491-H.P. MANUFACTURED BY EUCLID CHEMICAL CO. OF CLEVELAND, OHIO OR SP-10 MANUFACTURED BY BAIRD DYNAMICS COMPANY OF BRIDGEPORT, CONNECTICUT OR EQUIVALENT SHALL BE MIXED ACCORDING TO DIRECTIONS, POURED INTO THE SAWSLOTS AND LEFT UNDISTURBED UNTIL CURED INTO A SOLID MASS.

*** DIMENSIONS**

IN CASES WHERE THE LATERAL DIMENSION WOULD BE LESS THAN EIGHT (8) FEET, THE LONGITUDINAL DIMENSION SHALL BE INCREASED TO OBTAIN A MINIMUM AREA OF 48 S.F.

BUREAU OF TRAFFIC OHIO DEPARTMENT OF HIGHWAYS	
EMBEDDED VEHICLE DETECTOR LOOP DETAILS	
APPROVED _____	ENGINEER OF TRAFFIC

Rev. 11-3-67
Rev. 6-1-71