

1

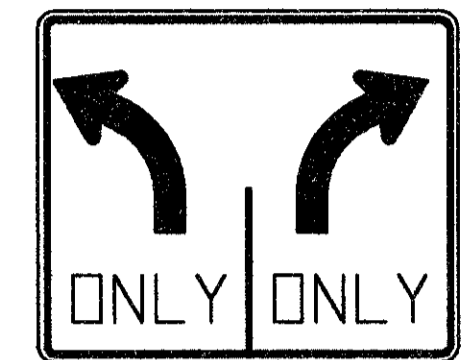

OW-128-36  
(200 FEET IN ADVANCE OF NEXT RELATED WARNING SIGN)

2



R-31F

3

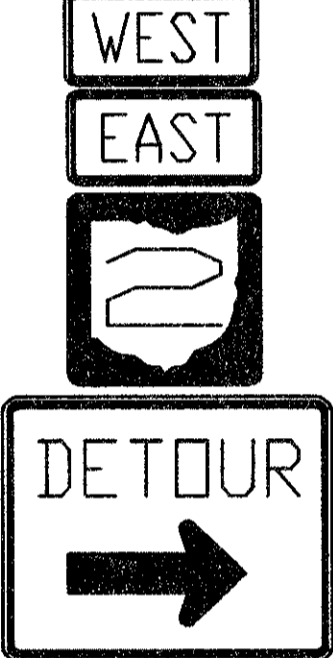

M-39, M-40, M-2 &  
OC-29R 30"X24"

4

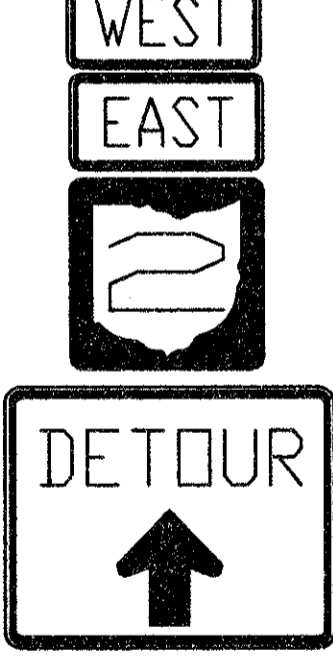

M-39, M-40, M-2 &  
OC-29 30"X24"

5

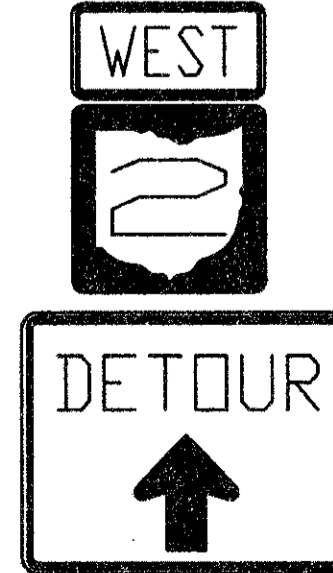

M-40, M-2 &  
OC-29 30"X24"

6

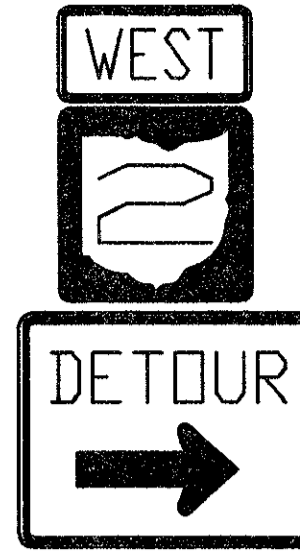

M-40, M-2 &  
OC-29R 30"X24"

7

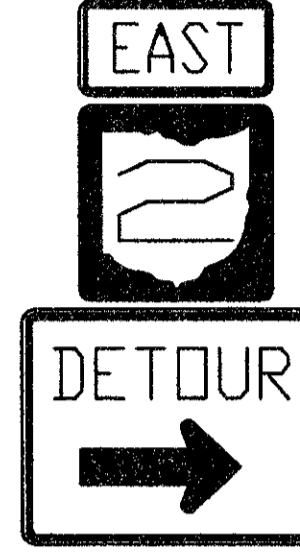

M-39, M-2 &  
OC-29R 30"X24"

8



M-39, M-2 &  
OC-29 30"X24"

9

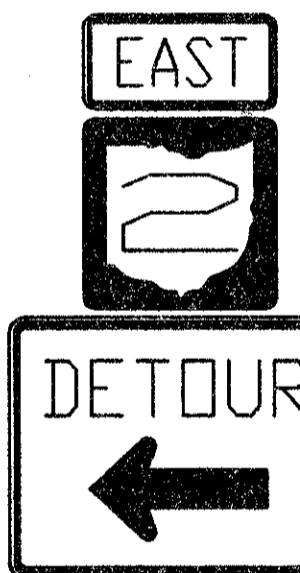

M-39, M-2 &  
OC-29L 30"X24"

10

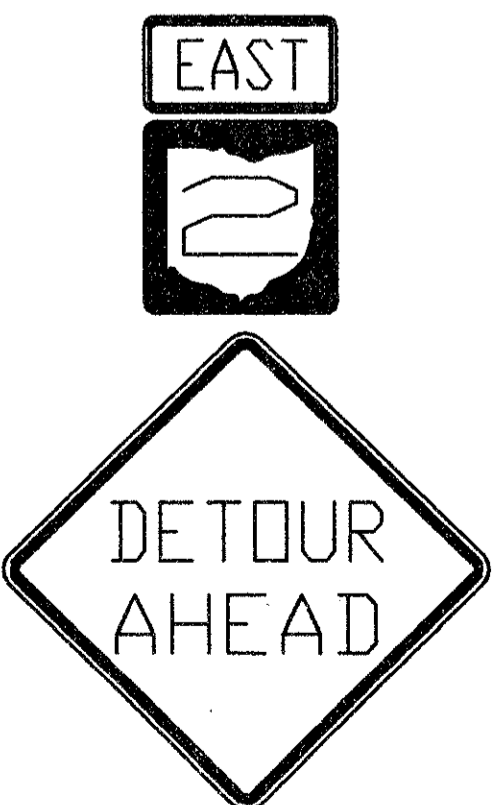

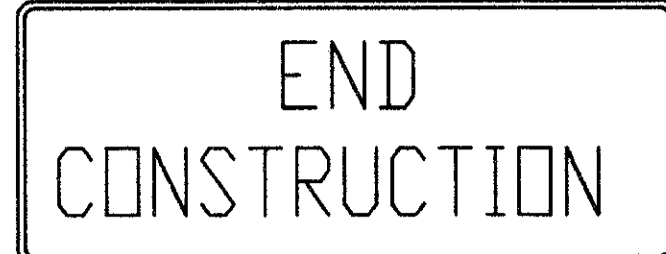

M-39, M-2 &  
OW-127-36  
(200 FEET PRIOR TO INTERSECTION)

11



OC-8 60"X24"

12

OW-132-36 &  
OW-145B 24"X18"  
(500 FEET PRIOR TO WORK ZONE)

13



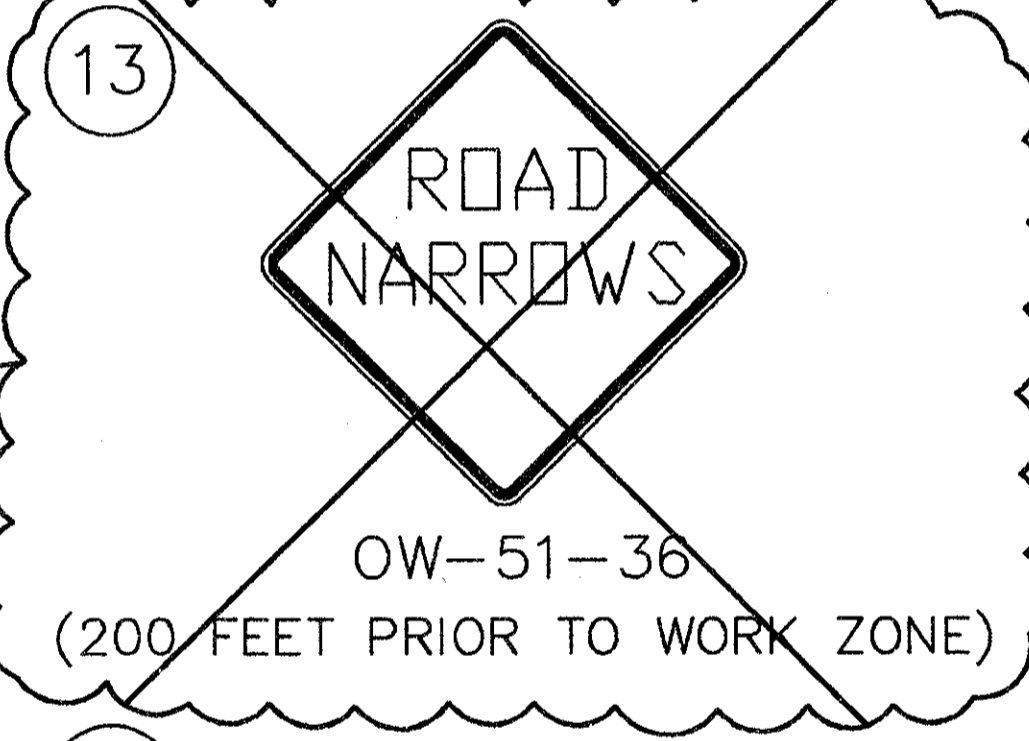

OW-51-36  
(200 FEET PRIOR TO WORK ZONE)

14



FLASHING ARROW PANEL

15

OW-122-36 &  
OW-145B 24"X18"  
(200 FEET PRIOR TO WORK ZONE)

16

OW-123-36 &  
OW-145B 24"X18"  
(200 FEET PRIOR TO WORK ZONE)

17



OW-60L-36  
(AT BEGINNING OF WORK ZONE TAPER)

18



OW-60R-36  
(AT BEGINNING OF WORK ZONE TAPER)

19



OW-145B 24"X18"

20



OW-127-36  
(400 FEET PRIOR TO WORK ZONE)

21



(200 FEET IN ADVANCE OF NEXT RELATED WARNING SIGN)

NO.	REVISIONS	BY	DATE
1	DELETE SIGN	JPR	8/3/00

H:\2000\00063\CAD\TRAFFIC\063MOT.DWG PLOT SCALE 1:12