

A	C	R	GAUGE
30	8	1 1/2	.080
36	8	1 1/2	.080

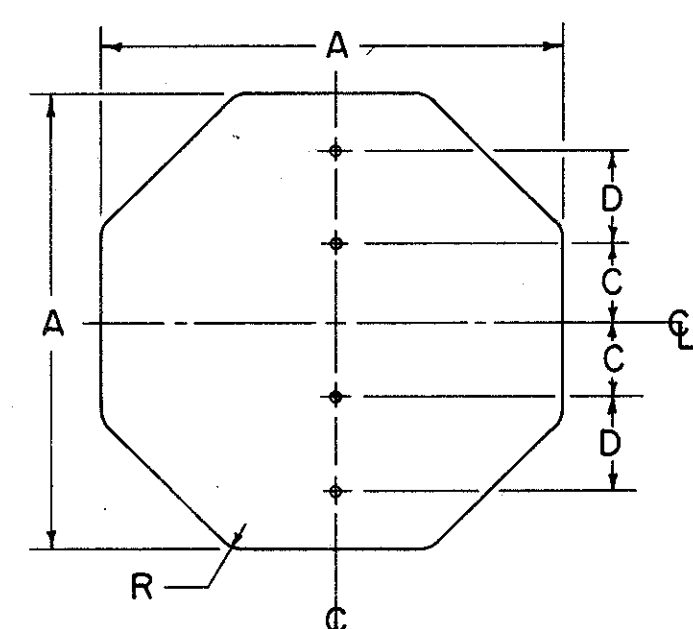

A	C	D	R	GAUGE
48	8	10	1 1/2	.100

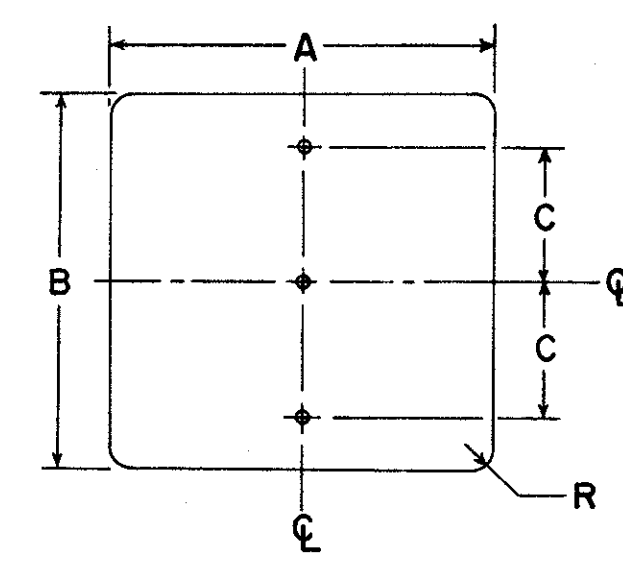

A	B	C	R	GAUGE
24	30	8	1 1/2	.063
24	48	15	1 1/2	.100
30	36	11	1 1/2	.080
30	42	12	1 1/2	.080
36	36	11	1 1/2	.080
36	42	15	1 1/2	.080
36	48	15	1 1/2	.080
48	24	10	3	.100
48	36	13	3	.100

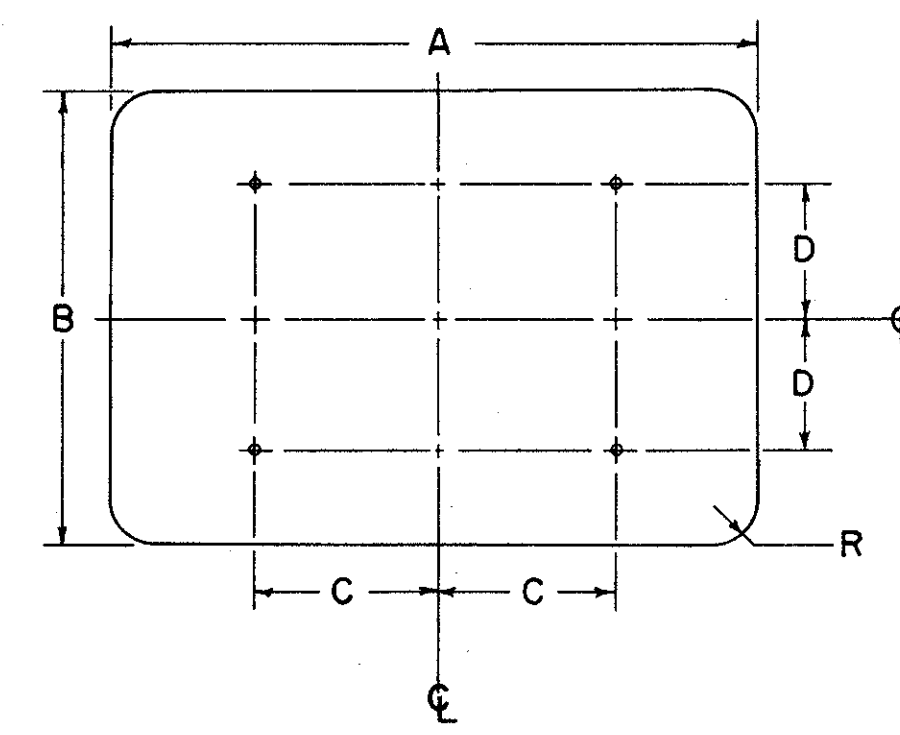

A	B	C	D	R	GAUGE
48	48	22	16	3	.100
48	60	22	22	3	.100

SPEED LIMIT SIGNS ON TWO SUPPORTS

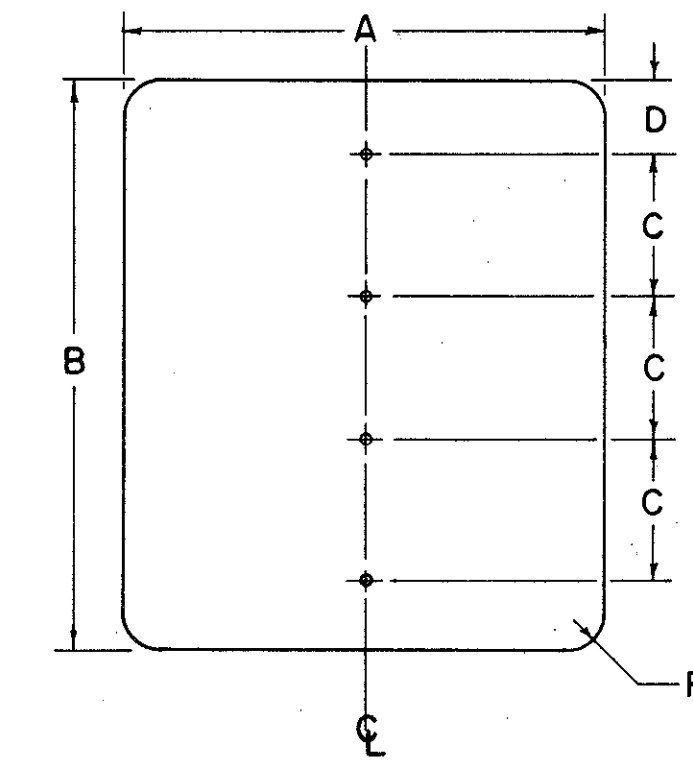

A	B	C	D	R	GAUGE
48	48	12	6	3	.100
48	60	15	7 1/2	3	.100

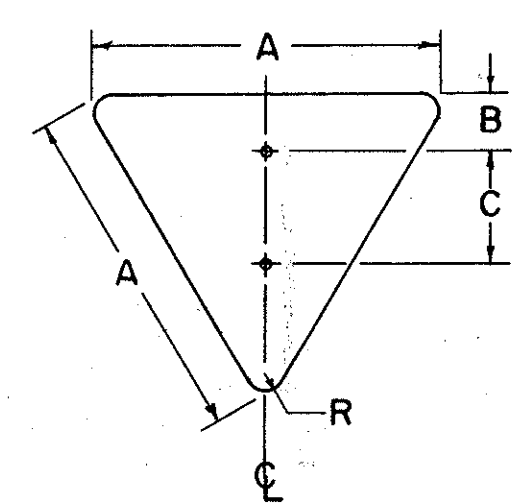

A	B	C	R	GAUGE
36	3	16	2 1/2	.080

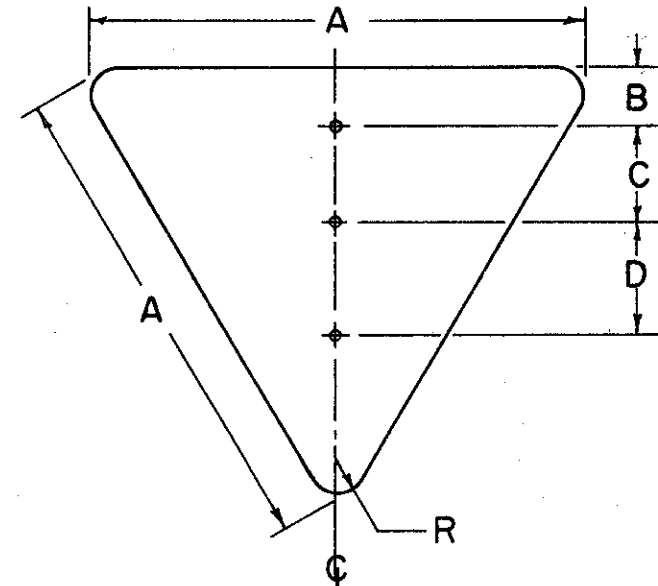

A	B	C	D	R	GAUGE
48	4	10	15	3	.100
60	5	10	15	4	.100

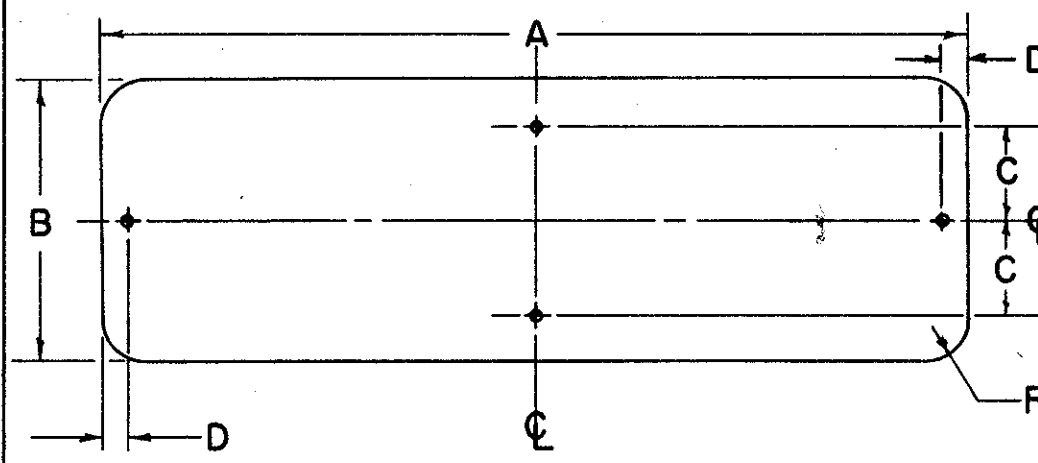

A	B	C	D	R	GAUGE
36	12	4	1	1 1/2	.080
72	12	-	16	1 1/2	.100
60	12	-	13	1 1/2	.100

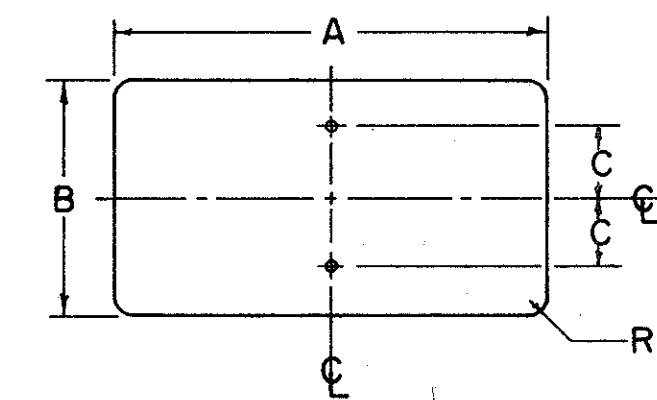

A	B	C	R	GAUGE
12	6	1 1/2	1 1/2	.063
20	15	6	1 1/2	.063
24	12	4 1/2	1 1/2	.063
24	18	7 1/2	1 1/2	.063
8	26	8	1	.063
36	18	7 1/2	1 1/2	.080

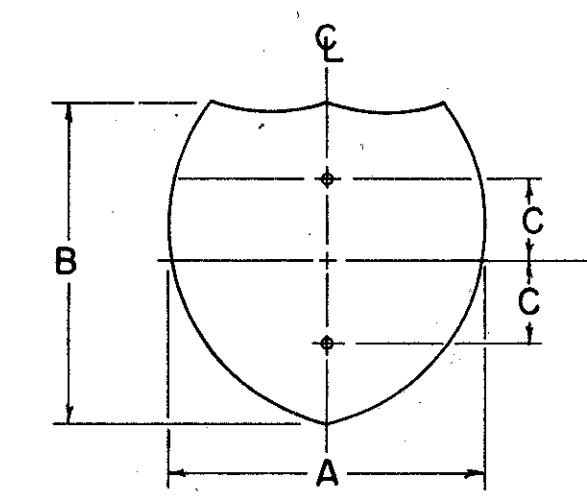

A	B	C	GAUGE
24	24	8	.063
30	24	8	.080

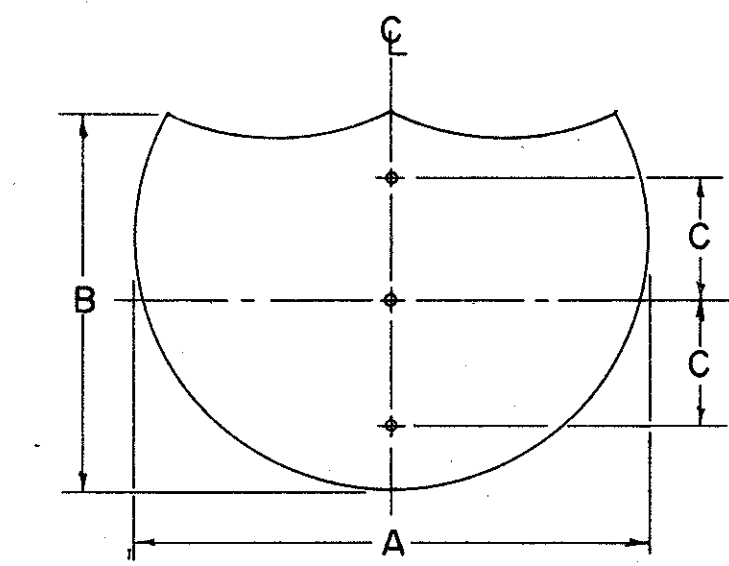

A	B	C	GAUGE
36	36	11	.080
48	36	11	.100

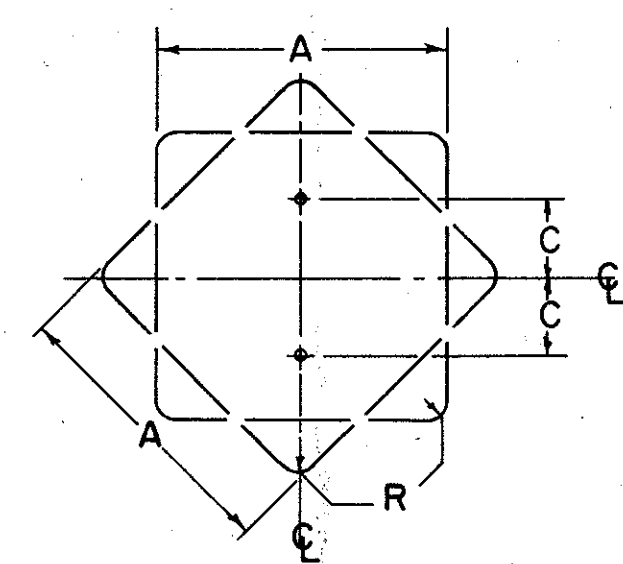

A	C	R	GAUGE
18	7 1/2	1 1/2	.063
24	8	1 1/2	.063
30	8	1 1/2	.080

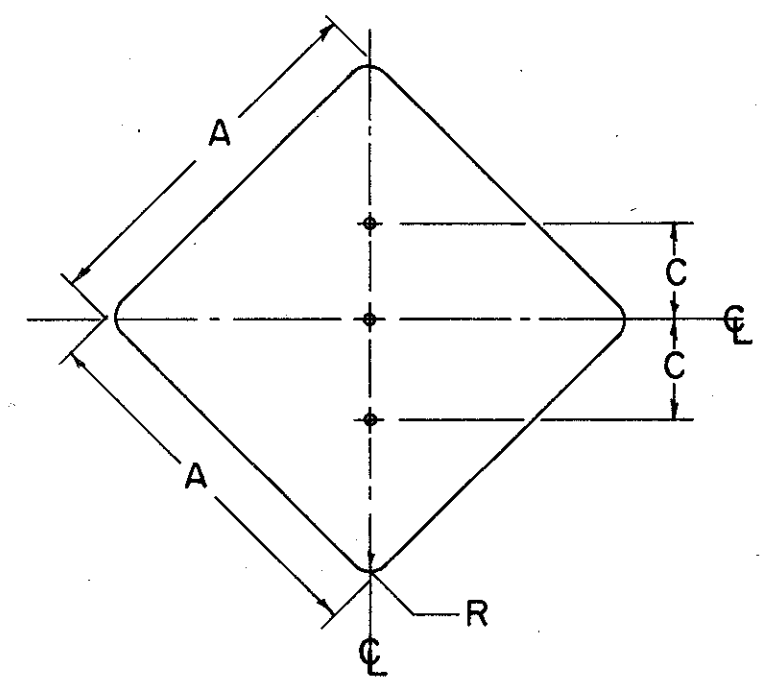

A	C	R	GAUGE
36	12	1 1/2	.080
48	14	3	.100

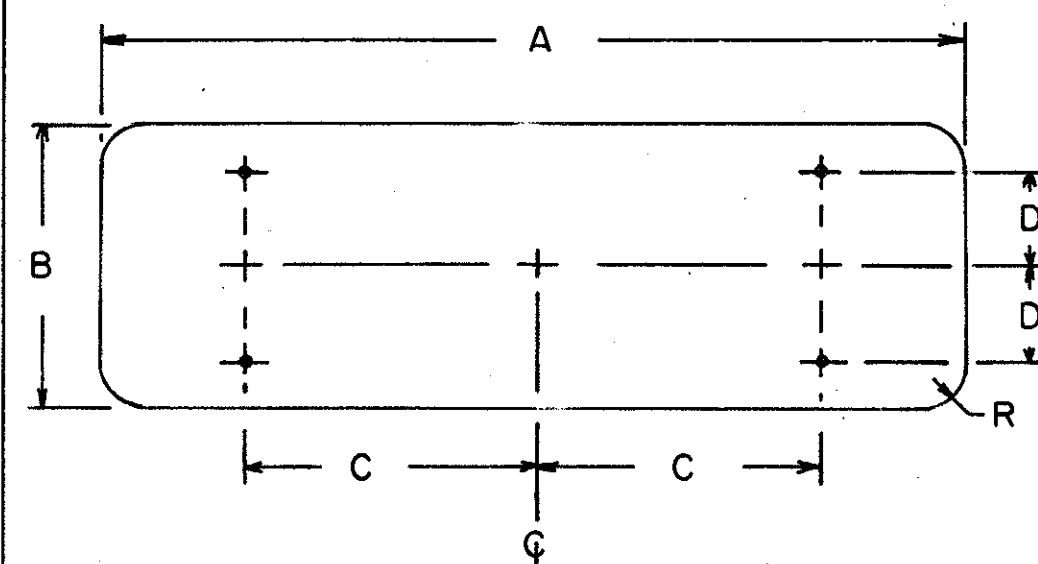

A	B	C	D	R	GAUGE
72	18	20	6	1 1/2	.100
72	24	20	8	1 1/2	.100
60	30	17	10	1 1/2	.100
96	18	27	6	1 1/2	.100

Location of holes on "Demountable Shields" (attached to guide signs)

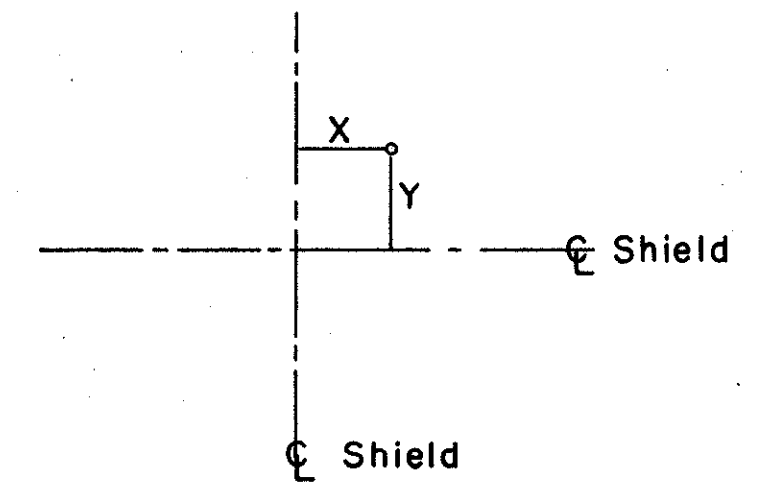

SIZE	NO. HOLES	X	Y
(26) 24X24	4	7	7
30X24	4	8	8
(39) 36X36	4	10	10
		0	10
48X36	6	15	10

For notes on fastening see drawing for miscellaneous "Signing Items" sheet.

NOTES:

ALL DIMENSIONS ARE IN INCHES UNLESS OTHERWISE SHOWN.

MATERIAL

FLAT SIGN BLANKS SHALL BE FURNISHED IN ALUMINUM ALLOY 6061-T6, (ASTM-B209, GS11A-T6) WITH MILL FINISH.

BOLT HOLES

THE BOLT HOLES SHALL BE 3/8" IN DIAMETER, AND MAY BE DRILLED, BLANKED OR PUNCHED TO FINISHED SIZE.

BUREAU OF TRAFFIC
OHIO DEPARTMENT OF HIGHWAYS

SIGN BLANK
DETAILS

SBD

APPROVED _____
ENGINEER OF TRAFFIC

DATE
4-14-67
5-10-68
10-1-68
5-27-69
6-18-69