

OCTA-1-3

A	B	C	THICKNESS	m <sup>2</sup>
750	75	300	2.0	0.56
900	150	300	2.0	0.81

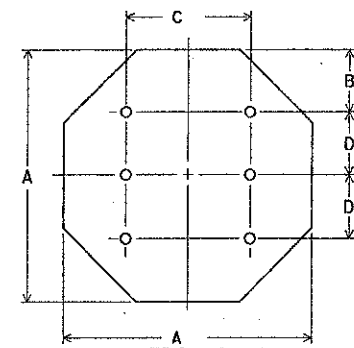

OCTA-2-6

A	B	C	D	THICKNESS	m <sup>2</sup>
1200	300	1600	1300	2.5	1.44

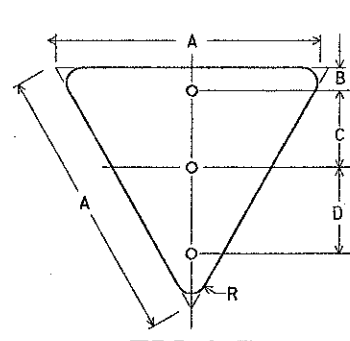

TRI-1-3

A	B	C	D	R	THICKNESS	m <sup>2</sup>
900	75	250	275	50	2.5	0.35

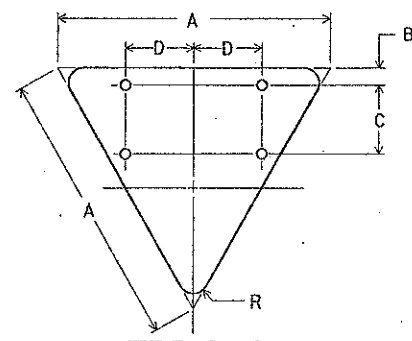

TRI-2-4

A	B	C	D	R	THICKNESS	m <sup>2</sup>
1200	75	300	300	75	2.5	0.62
1500	75	450	375	100	2.5	0.97

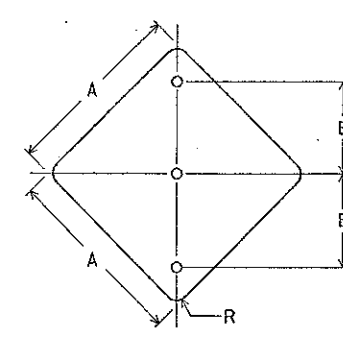

DIA-1-3

A	B	R	THICKNESS	m <sup>2</sup>
600	300	38	1.6	0.36
750	375	48	2.0	0.56
900	450	57	2.0	0.81

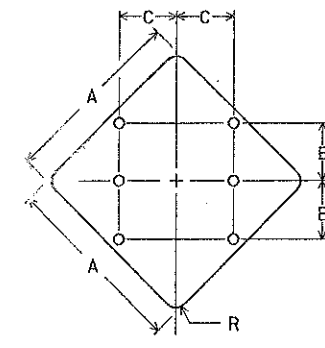

DIA-2-6

A	B	C	D	R	THICKNESS	m <sup>2</sup>
1200	375	375	75	2.5	1.44	
1500	450	450	95	2.5	2.25	

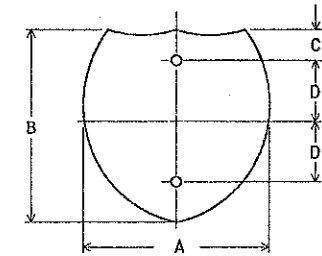

I.S.-1-2

A	B	C	D	THICKNESS	m <sup>2</sup>
600	600	75	225	1.6	0.36
750	600	75	225	2.0	0.45
750	750	75	300	2.0	0.56
1000	750	75	300	2.0	0.75

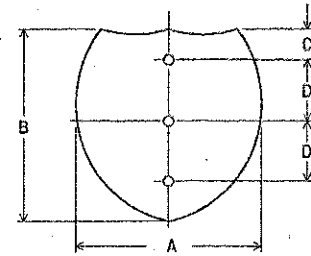

I.S.-1-3

A	B	C	D	THICKNESS	m <sup>2</sup>
900	900	150	300	2.0	0.81
1200	900	150	300	2.5	1.08

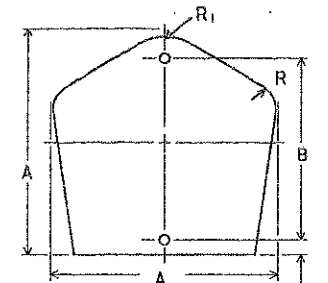

CO-1-2

A	B	C	R <sub>1</sub>	R	THICKNESS	m <sup>2</sup>
450	375	25	125	50	1.6	0.20
600	450	50	135	68	1.6	0.36
750	600	50	168	86	2.0	0.56

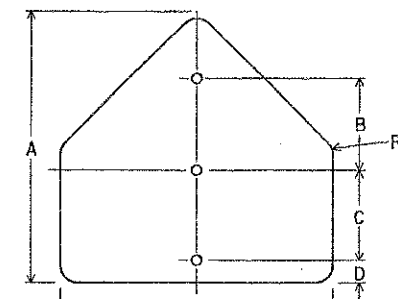

PENT-1-3

A	B	C	D	R	THICKNESS	m <sup>2</sup>
750	250	275	75	48	2.0	0.56
900	300	300	75	57	2.0	0.81
1050	350	325	100	64	2.5	1.10

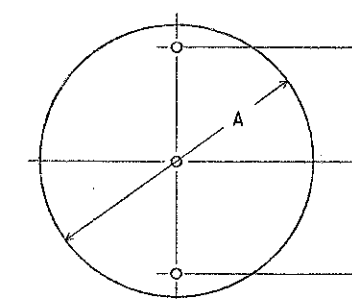

CIR-1-3

A	B	THICKNESS	m <sup>2</sup>
750	300	1.6	0.56
900	375	2.0	0.81

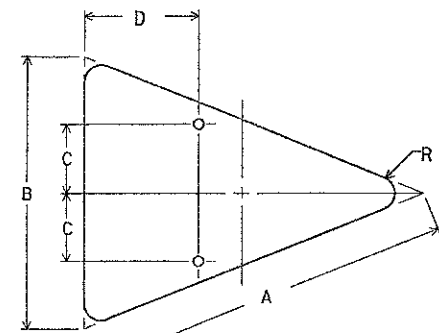

ISOS-1-2

A	B	C	D	R	THICKNESS	m <sup>2</sup>
1000	750	187	300	48	2.0	0.35
1200	900	225	375	57	2.5	0.50

ROUTE SHIELDS  
(FOR GUIDE SIGNS ONLY)

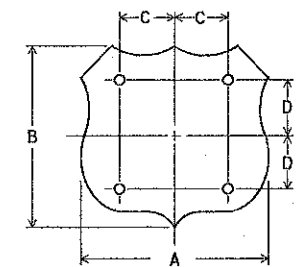

M-1C-

A	B	C	D
610	600	175	175
750	600	200	200
750	750	225	225
937	750	225	225
900	900	250	250
1125	900	375	250

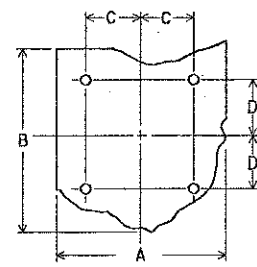

M-2C-

A	B	C	D
600	600	175	175
750	600	200	200
750	750	225	225
937	750	225	225
900	900	250	250
1125	900	375	250

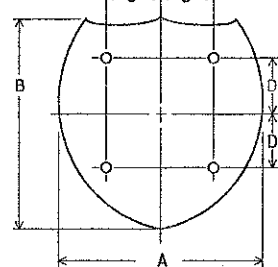

M-5C-

A	B	C	D
600	600	175	175
750	600	200	200
750	750	225	225
1000	750	225	225
900	900	250	250
1200	900	375	250

ALL SHIELDS SHALL BE 1.6 mm THICK

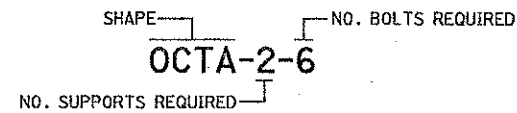

NOTES

1. ALL DIMENSIONS ARE IN MILLIMETERS, UNLESS OTHERWISE NOTED.
2. ALL BOLT HOLES SHALL BE 10 MILLIMETERS IN DIAMETER, AND MAY BE DRILLED OR PUNCHED TO FINISHED SIZE.
3. DIMENSIONS BETWEEN BOLT HOLES SHALL BE TO TOLERANCE OF ± 0.8 MILLIMETER.
4. FOR ADDITIONAL BLANK DETAILS, SEE SIGN LAYOUT DRAWING.

METRIC

BUREAU OF DESIGN SERVICES  
DIVISION OF HIGHWAYS  
OHIO DEPARTMENT OF TRANSPORTATION

TRAFFIC CONTROL

SIGN BLANK DETAILS I

STANDARD CONSTRUCTION DRAWING TC-52.10M

APPROVED *[Signature]* ENGR. OF DESIGN SERVICES

DATE  
07/29/94