

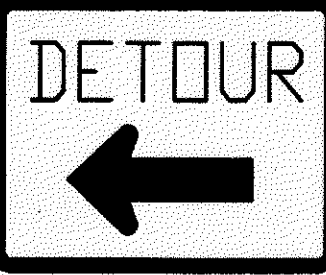
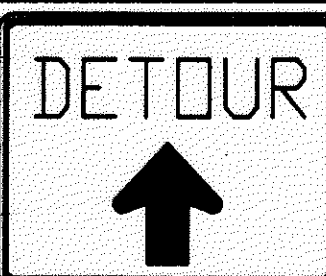
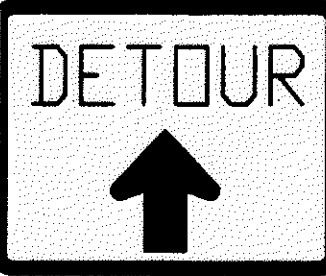
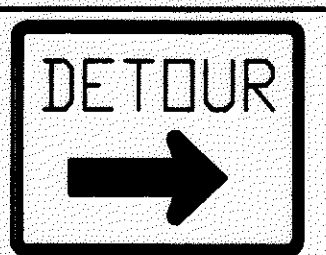

20 VINE STREET

 STREET SIGN &
 OC-29L 762mmX610mm(30"X24")

21 VINE STREET

 STREET SIGN &
 OC-29 762mmX610mm(30"X24")

22 E. 364 ST.

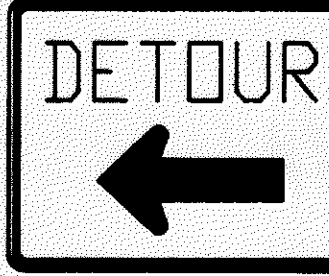
 STREET SIGN &
 OC-29 762mmX610mm(30"X24")

23 E. 364 ST.
 E. 359 ST.
 E. 357 ST.
 E. 354 ST.

 4 STREET SIGNS &
 OC-29R 762mmX610mm(30"X24")

24 E. 364 ST.
 E. 359 ST.
 E. 357 ST.
 E. 354 ST.

 4 STREET SIGNS &
 OW-127-36
 (61 METERS PRIOR TO INTERSECTION)

25 E. 364 ST.
 E. 359 ST.
 E. 357 ST.
 E. 354 ST.

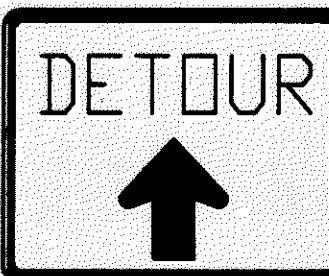
 4 STREET SIGNS &
 OC-29L 762mmX610mm(30"X24")

26 E. 354 ST.

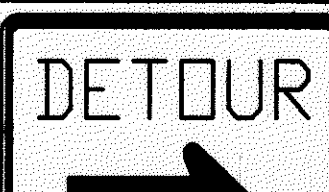
 STREET SIGN &
 OC-29R 762mmX610mm(30"X24")

27 E. 364 ST.
 E. 359 ST.
 E. 357 ST.

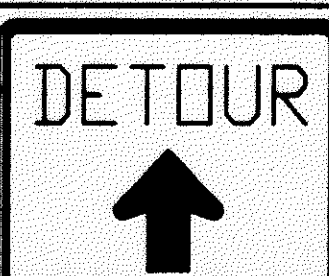
 3 STREET SIGNS &
 OC-29 762mmX610mm(30"X24")

28 E. 359 ST.
 E. 357 ST.

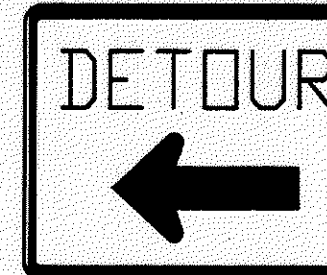
 2 STREET SIGNS &
 OC-29R 762mmX610mm(30"X24")

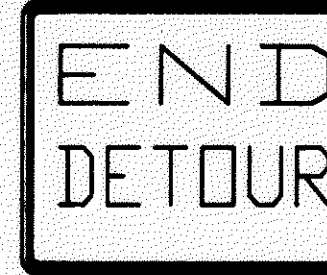
29 E. 364 ST.

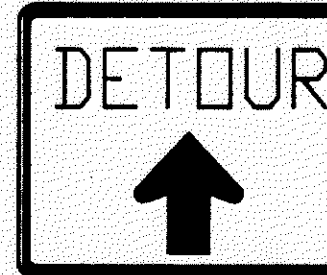
 STREET SIGN &
 OC-29 762mmX610mm(30"X24")

30 E. 359 ST.

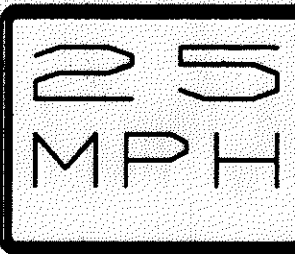
 STREET SIGN &
 OC-29L 762mmX610mm(30"X24")
 (AT BEGINNING OF WORK ZONE TAPER)

31 E. 364 ST.

 STREET SIGN &
 OW-145B 610mmX457mm(24"X18")

32 E. 364 ST.
 E. 359 ST.
 E. 357 ST.
 E. 354 ST.

 4 STREET SIGNS &
 OC-29 762mmX610mm(30"X24")

33 SHOULDER WORK AHEAD

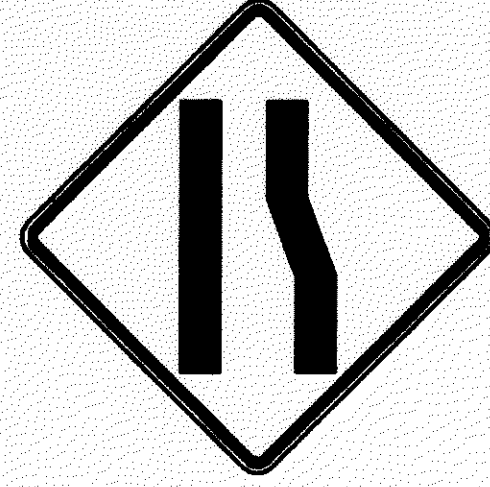
 25 MPH

 OW-132-36 &
 OW-145B 610mmX457mm(24"X18")
 (153 METERS PRIOR TO WORK ZONE)

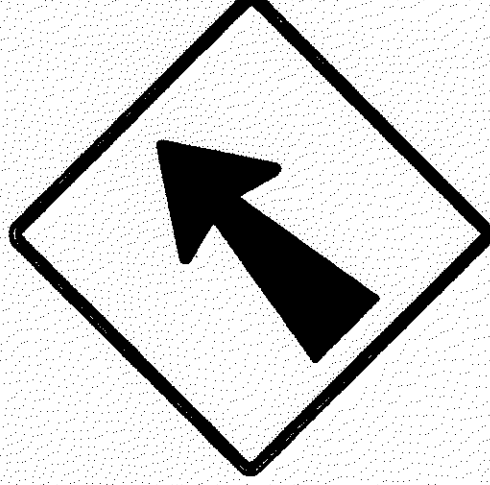
34 ROAD NARROWS

 OW-51-36
 (61 METERS PRIOR TO WORK ZONE)

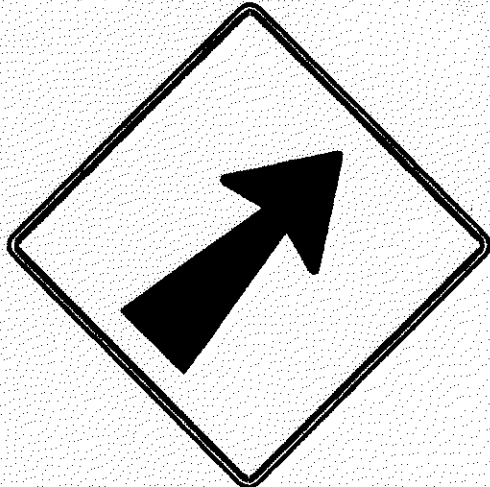
35 
 OW-60L-36
 (AT BEGINNING OF WORK ZONE TAPER)

36 
 OW-60R-36
 (AT BEGINNING OF WORK ZONE TAPER)

37 
 OW-138-30
 (AT BEGINNING OF LANE SHIFT)

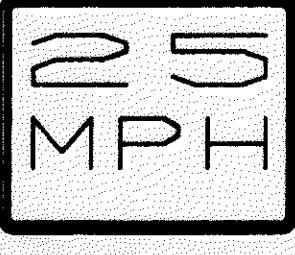
38 
 OW-138-30
 (AT BEGINNING OF LANE SHIFT)

39 LEFT LANE CLOSED AHEAD

 25 MPH

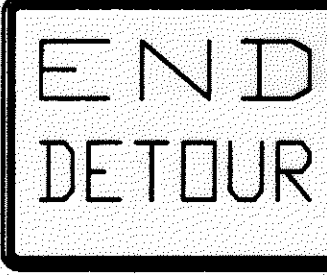
 OW-123-36 &
 OW-145B 610mmX457mm(24"X18")
 (61 METERS PRIOR TO WORK ZONE)

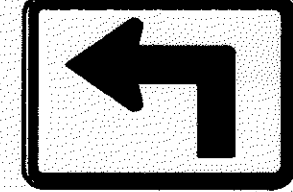
40 ROAD CONSTRUCTION AHEAD

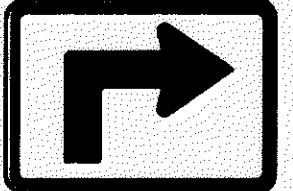
 OW-128-36
 (122 METERS PRIOR TO WORK ZONE)

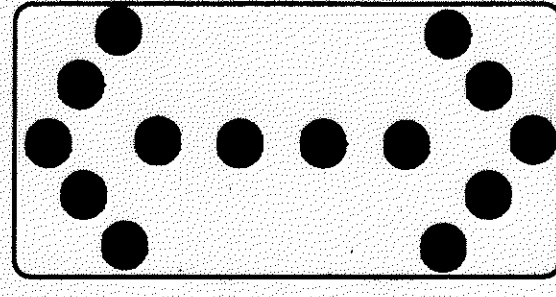
41 E. 361 ST.

 STREET SIGN &
 OW-145B 610mmX457mm(24"X18")

42 DETOUR
 E. 361 ST.

 OM-23,
 STREET SIGN &
 OM-21-21
 (INSTALLED ON MEDIAN AND EDGE
 OF PAVEMENT HALF-WAY BETWEEN
 VINE ST. AND CURTIS BLVD.)

43 DETOUR
 E. 361 ST.
 E. 361 ST.
 E. 361 ST.
 E. 361 ST.

 OM-23,
 4 STREET SIGNS &
 OM-19-21
 (INSTALLED HALF-WAY BETWEEN
 VINE ST. AND STEVENS BLVD.)

44 
 FLASHING ARROW PANEL
 1219mmX610mm(48"X24")