

STANDARD CONCRETE CURBS AND COMBINED CURB AND GUTTER

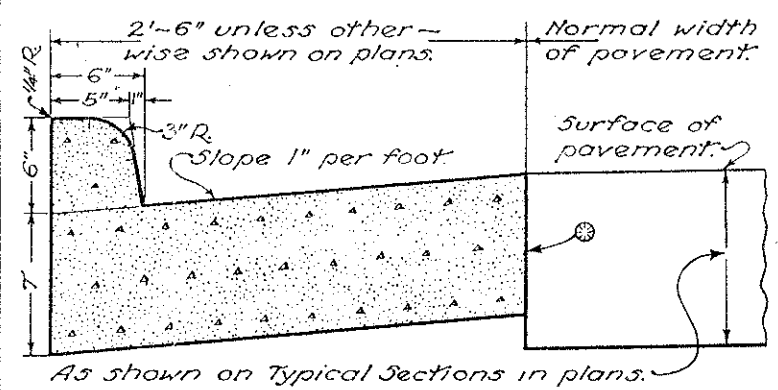

TYPE 2

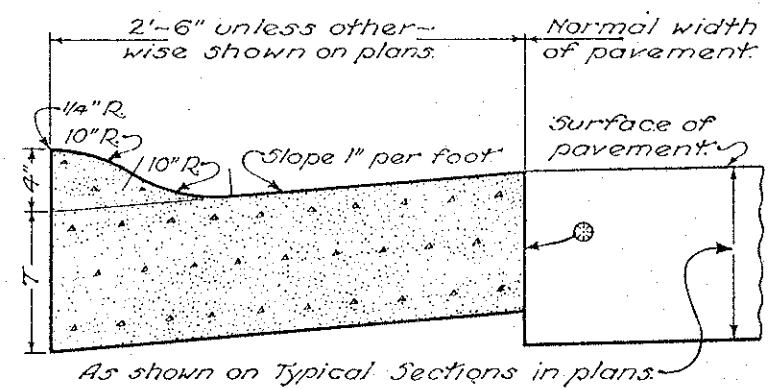

TYPE 3

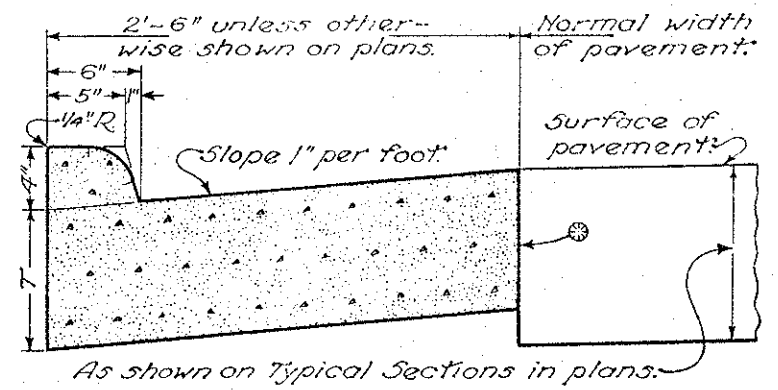

TYPE 4

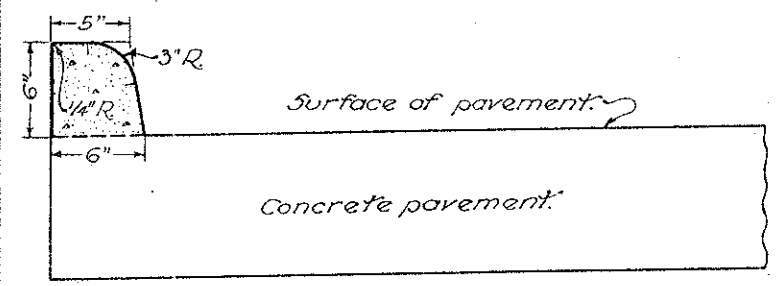

TYPE 2-A

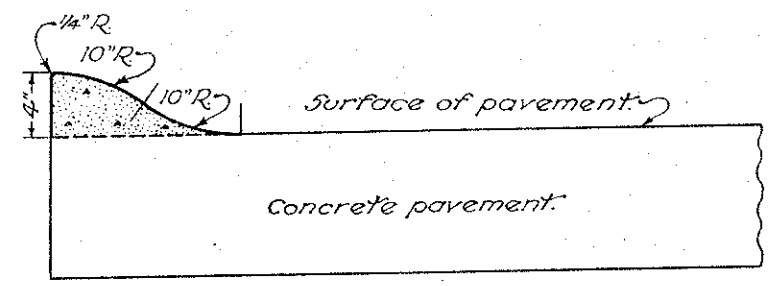

TYPE 3-A

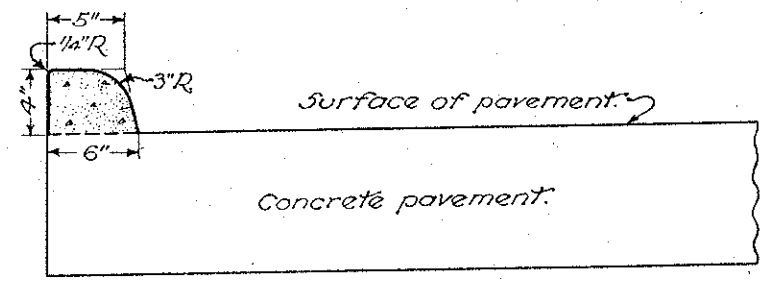

TYPE 4-A

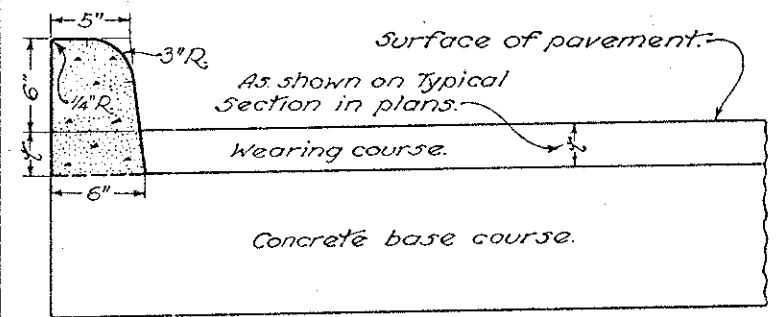

TYPE 2-B

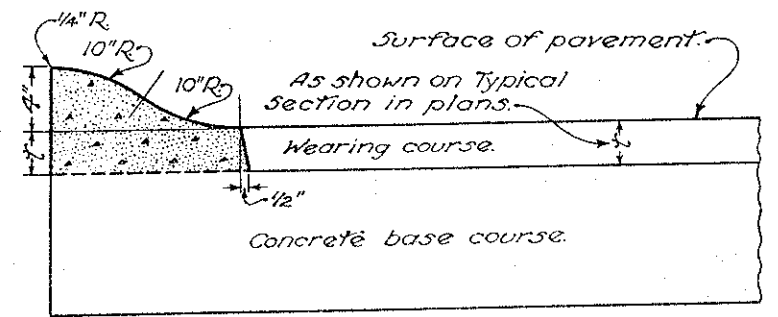

TYPE 3-B

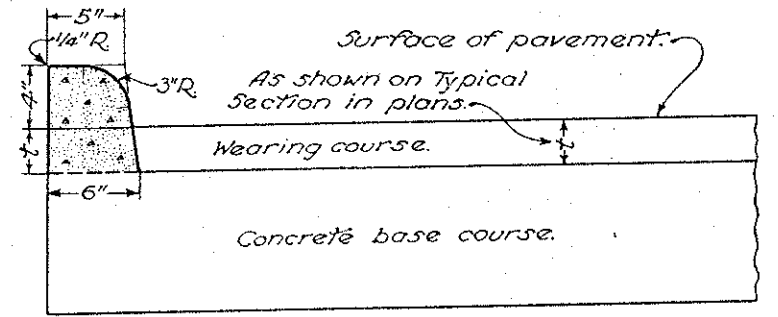

TYPE 4-B

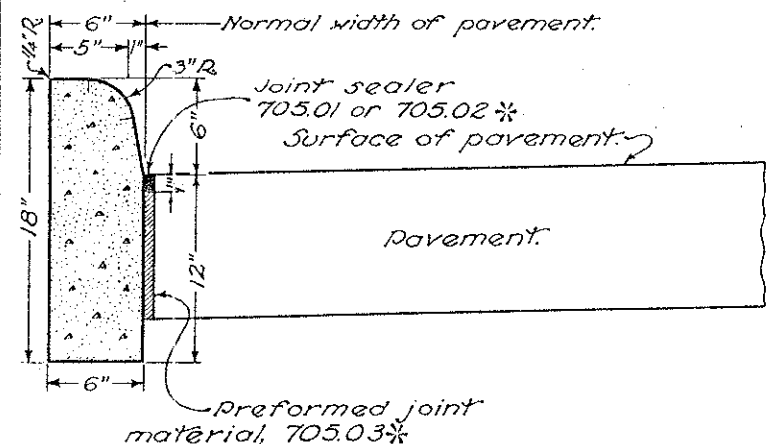

TYPE 6

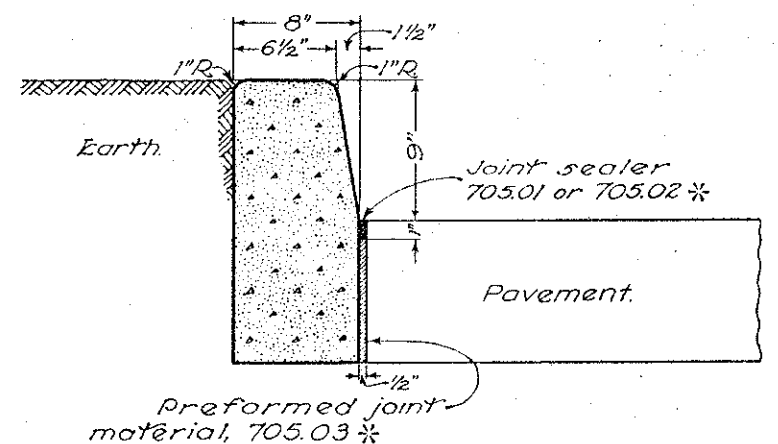

TYPE 7

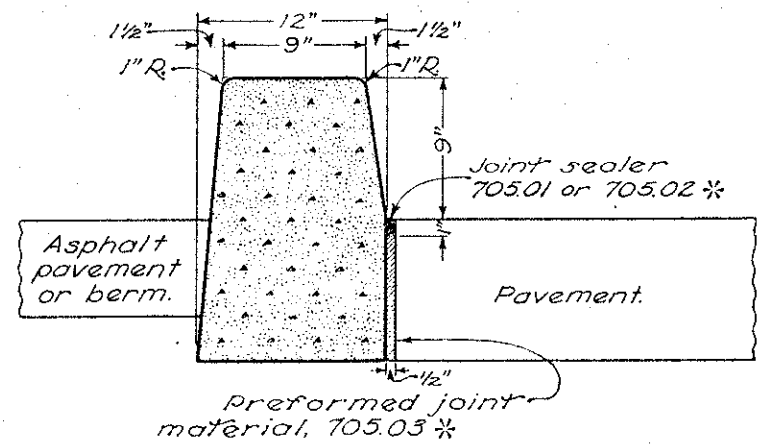

TYPE 8

NOTES

GENERAL: This drawing shows alternate types of curb that may be used on various types of pavement. Typical section of project shows the type to be used, also the thickness of the edge of the pavement or the edge of the curb and gutter section.

JOINTS: One inch expansion joints shall extend up to the top of the curb and shall be constructed in the curb and gutter section in such a manner that the joint seal will extend the full width of the gutter and into the curb face a sufficient distance to seal the joint to an elevation of at least two (2) inches above the flow line of the gutter. Dowel bars shall be used in the curb and gutter section at expansion joints which are identical with the joints in the pavement.

All joints shall be constructed perpendicular to the edge of the curb and to the surface of the pavement.

Transverse expansion joint material shall meet the requirements of 705.03.

* Expansion joint material and joint sealer is not required when curb is adjacent to flexible type pavement.

⊙ Butt joints shall be provided between combined curb-and-gutter and new rigid pavements, with tie bars or hook bolts provided at five foot intervals. Combined curb-and-gutter shall be tied to existing rigid pavements with expansion hook bolts spaced at five foot intervals. If the combined curb-and-gutter adjoins a new rigid base or an existing rigid base or pavement that is to be surfaced with bituminous material, a butt joint shall be provided and tie bars, hook bolts or expansion hook bolts shall be omitted.

Thickness of gutter plate "T" shall be 9 inches unless otherwise shown on the plans.

BUREAU OF LOCATION AND DESIGN OHIO DEPARTMENT OF TRANSPORTATION	
CONCRETE CURBS AND COMBINED CURB AND GUTTER	
STANDARD CONSTRUCTION DRAWING	
BP-7	
APPROVED <i>[Signature]</i> ENGR., L. & D.	

DATE
6-1-'65
1-1-'66
12-6-'76